

DOORS / DOOR PARTS

QUICK LOCATOR GUIDE

Aircraft Cable	248
Astragals	230-231
Belts	254
Car Sills	241
Doors	243-246
Doors for Residential Elevators	242
Door Gibs / Door Bumpers	232-236
Door Keys	250-251
Door Latch Assembly	260
Door Restrictor	261
Door Roller Guide Kits	236
Door Wedge Tools	240
Electric Eye Assemblies	255
Escutcheons	253-254
Fire Tabs	238
Freight Straps	248
Guards, Toe/Platform	239
Hatch Exit	260
Hatch Sills	241
Safety Edge	255-257
SEEScreen	255-257
SEES Door Wedge Tool	240
SEES Enforcer	232-233
SEES Light Curtain	255
SEES Restrictor	261
SEES Z-Brackets	238
Sills	241
Spirators, Reel Closers	249
Top Retainers	261-262
Z Brackets	238

Astragals

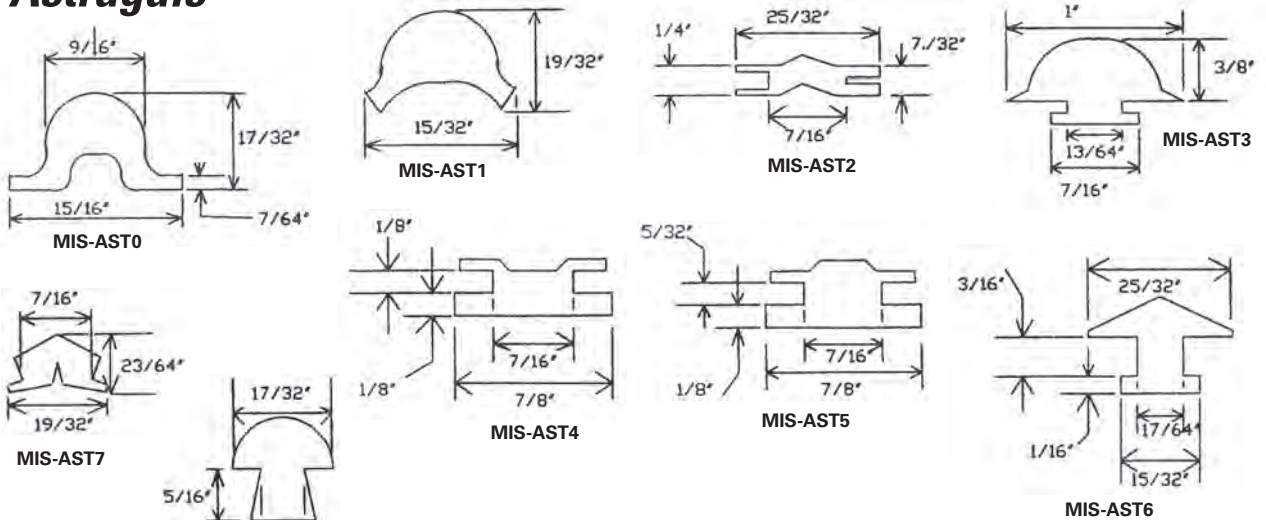

S.E.E.S. #	Description
MIS-AST0	Astragal, Door, #100, replacement for Hoistway, 8 ft. section
MIS-AST0A	Astragal, Door, #100, replacement for Hoistway, 10 ft. section
MIS-AST1	Astragal, Door, #101, side opening, 8 ft. section
MIS-AST1A	Astragal, Door, #101, side opening, 10 ft. section
MIS-AST2	Astragal, Door, #102, reversing, 8 ft. section
MIS-AST2A	Astragal, Door, #102, reversing, 10 ft. section
MIS-AST3	Astragal, Door, #103, side opening, 8 ft. section
MIS-AST3A	Astragal, Door, #103, side opening, 10 ft. section
MIS-AST4	Astragal, Door, #104, companion part to MIS-AST5, 8 ft. section
MIS-AST4A	Astragal, Door, #104, companion part to MIS-AST5A, 10 ft. section
MIS-AST5	Astragal, Door, #105, companion part to MIS-AST4, 8 ft. section
MIS-AST5A	Astragal, Door, #105, companion part to MIS-AST4A, 10 ft. section
MIS-AST6	Astragal, Door, #106, 8 ft. section
MIS-AST6A	Astragal, Door, #106, 10 ft. section
MIS-AST7	Astragal, Door, #107, side opening, 8 ft. section
MIS-AST7A	Astragal, Door, #107, side opening, 10 ft. section
MIS-AST8	Astragal, Door, #108, side opening, 8 ft. section
MIS-AST8A	Astragal, Door, #108, side opening, 10 ft. section
MIS-AST9	Astragal, Door, #109, reversing, replacement for Otis & Esco, 8 ft. section
MIS-AST9A	Astragal, Door, #109, reversing, replacement for Otis & Esco, 10 ft. section
MIS-AST10	Astragal, Door, #110, fits 7/16" groove, 8 ft. section
MIS-AST10A	Astragal, Door, #110, fits 7/16" groove, 10 ft. section
MIS-AST11	Astragal, Door, #111, reversing 3/8" groove, 8 ft. section
MIS-AST11A	Astragal, Door, #111, reversing 3/8" groove, 10 ft. section
MIS-AST12	Astragal, Door, #112, side opening, 8 ft. section
MIS-AST12A	Astragal, Door, #112, side opening, 10 ft. section
MIS-AST15	Astragal, Door, #115, companion part to MIS-AST16, 8 ft. section
MIS-AST15A	Astragal, Door, #115, companion part to MIS-AST16, 10 ft. section
MIS-AST16	Astragal, Door, #116, companion part to MIS-AST15, 8 ft. section
MIS-AST16A	Astragal, Door, #116, companion part to MIS-AST15, 10 ft. section
MIS-AST17	Astragal, Door, #117, side opening, 8 ft. section
MIS-AST17A	Astragal, Door, #117, side opening, 10 ft. section
MIS-AST18	Astragal, reversing 8 ft. length
MIS-AST18A	Astragal, reversing 10 ft. length
MIS-AST19	Astragal, Door, #119, glue on replacement, 8 ft. section
MIS-AST19A	Astragal, Door, #119, glue on replacement, 10 ft. section

* Please call if your required Astragal is not listed

Astragals

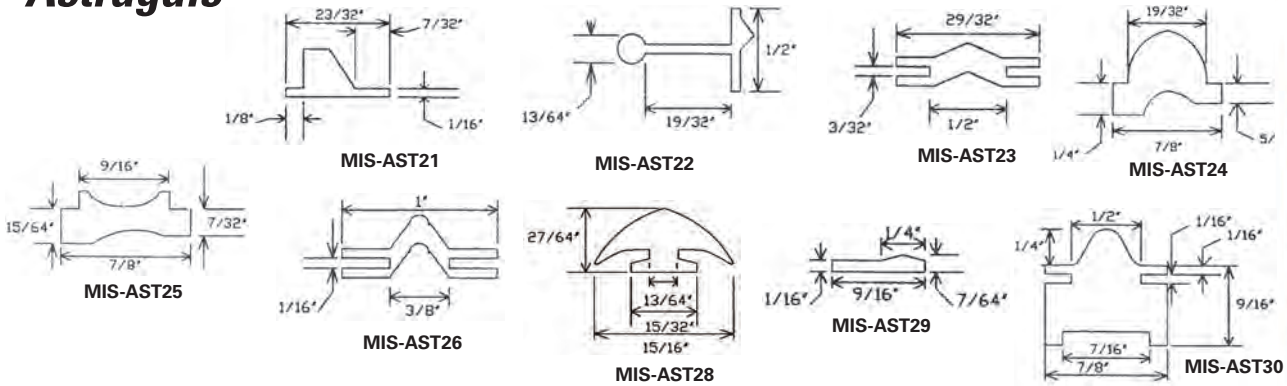

S.E.E.S. #	Description
MIS-AST21	Astragal, Door, #121, side opening, 8 ft. section
MIS-AST21A	Astragal, Door, #121, side opening, 10 ft. section
MIS-AST22	Astragal, Door, #122, reversing, 8 ft. section
MIS-AST22A	Astragal, Door, #122, reversing, 10 ft. section
MIS-AST23	Astragal, Door, #123, reversing, 8 ft. section
MIS-AST23A	Astragal, Door, #123, reversing, 10 ft. section
MIS-AST24	Astragal, Door, #124, companion part to MIS-AST25, 8 ft. section
MIS-AST24A	Astragal, Door, #124, companion part to MIS-AST25A, 10 ft. section
MIS-AST25	Astragal, Door, #125, companion part to MIS-AST24, 8 ft. section
MIS-AST25A	Astragal, Door, #125, companion part to MIS-AST24A, 10 ft. section
MIS-AST26	Astragal, Door, #126, reversing, 8 ft. section
MIS-AST26A	Astragal, Door, #126, reversing, 10 ft. section
MIS-AST28	Astragal, Door, #128, side opening, 8 ft. section
MIS-AST28A	Astragal, Door, #128, side opening, 10 ft. section
MIS-AST29	Astragal, Door, #129, 8 ft. section
MIS-AST29A	Astragal, Door, #129, 10 ft. section
MIS-AST30	Astragal, Door, #130, companion part to MIS-AST31, 8 ft. section
MIS-AST30A	Astragal, Door, #130, companion part to MIS-AST31A, 10 ft. section
MIS-AST31	Astragal, Door, #131, companion part to MIS-AST30, 8 ft. section
MIS-AST31A	Astragal, Door, #131, companion part to MIS-AST30A, 10 ft. section
MIS-AST32	Astragal, Door, #132, reversing, 8 ft. section
MIS-AST32A	Astragal, Door, #132, reversing, 10 ft. section
MIS-AST32-EXT7	Astragal Excursion, 7ft.
MIS-AST33	Astragal, Mates to MIS-AST34, 8 ft.
MIS-AST33A	Astragal, Mates to MIS-AST34A, 10 ft.
MIS-AST34	Astragal, Mates to MIS-AST33, 8 ft.
MIS-AST34A	Astragal, Mates to MIS-AST33A, 10 ft.
MIS-AST41	Astragal, 8 Ft. .625 x .425 x .905
MIS-AST45	Astragal, 8 Ft. .6875 x .5 x .625, 145-08
MIS-AST45A	Astragal, 10 Ft. .6875 x .5 x .625, 145-10
MIS-AST47	Astragal, used on #47 elevator equipment 8 ft.
MIS-AST48	Astragal (universal) self adhesive, sold per foot
MIS-AST49	Astragal, Dover 8' Section
MIS-AST50	Astragal, Montgomery Stay 80 84.5" Section
MIS-AST146	Astragal, #146, 9/16 x 11/32 x 15/32, 8' Section
MIS-AST148	Astragal, #148 8' Section
MIS-AST148A	Astragal, #148, 10' Section
MIS-AST149	Astragal, 8 Ft. .688 x .5 x .937
MIS-AST150	Astragal, 8 Ft. .688 x .562 x .938
MIS-AST001A	Astragal, Dual Slot 10' Reversible
MIS-AST200	Astragal, T Profile 108-1/2" Long
MIS-AST32-EXT7	Astragal, 7ft.

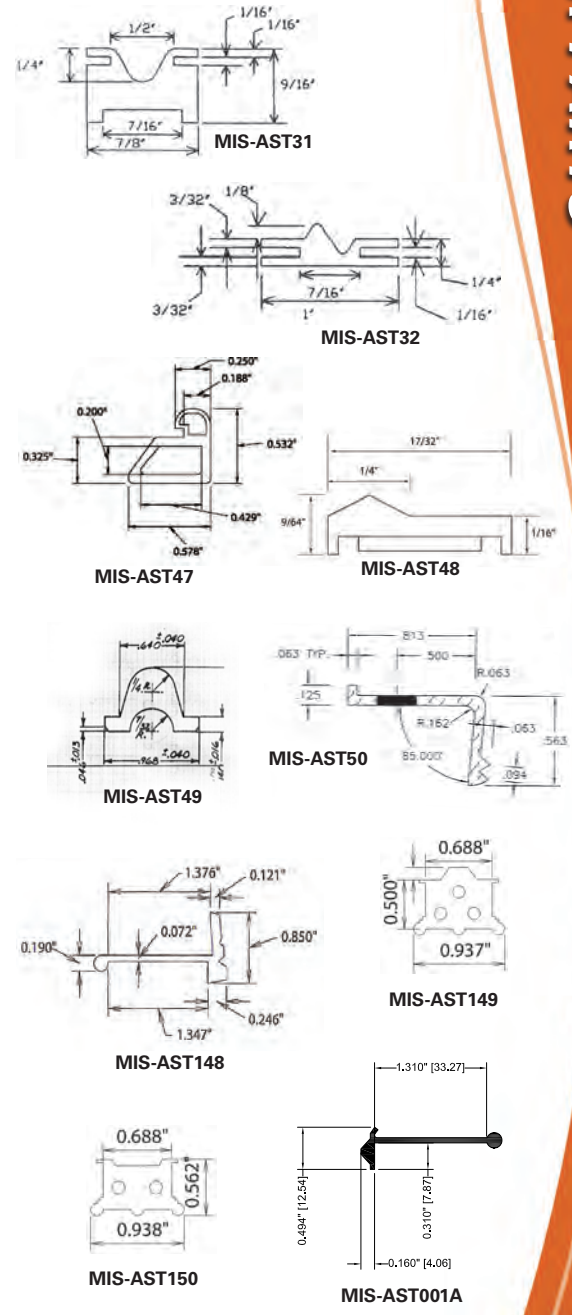

* Please call if your required Astragal is not listed



The Enforcer

Door Gibs. Redefined.

SEES-ENFORCER-001
7/16"SEES-ENFORCER-002
15/32"SEES-ENFORCER-003
1/2"SEES-ENFORCER-004
17/32"

SEES Enforcer Door Gib Kits

S.E.E.S. #	Description
SEES-ENFORCER-001	SEES Safety Door Guide, Heavy Duty, Stainless Steel, Adjustable guide, with 7/16" nylon gib, minimum offset: .312" maximum offset: .968"
SEES-ENFORCER-002	SEES Safety Door Guide, Heavy Duty, Stainless Steel, Adjustable guide, with 15/32" nylon gib, minimum offset: .312" maximum offset: .968"
SEES-ENFORCER-003	SEES Safety Door Guide, Heavy Duty, Stainless Steel, Adjustable guide, with 1/2" nylon gib, minimum offset: .312" maximum offset: .968"
SEES-ENFORCER-004	SEES Safety Door Guide, Heavy Duty, Stainless Steel, Adjustable guide, with 17/32" nylon gib, minimum offset: .312" maximum offset: .968"
SEES-ENFORCER-010	SEES Safety Door Guide, Heavy Duty, Stainless Steel, Adjustable guide, with 23/64" nylon gib, minimum offset: .312" maximum offset: .968"
SEES-ENFORCER-FT	Door Gib, Fire tab, Stainless Steel
SEES-ENFORCER-GIB-001	Replacement Door Gib, Nylon, 7/16" wide
SEES-ENFORCER-GIB-002	Replacement Door Gib, Nylon, 15/32" wide
SEES-ENFORCER-GIB-003	Replacement Door Gib, Nylon, 1/2" wide
SEES-ENFORCER-GIB-004	Replacement Door Gib, Nylon, 17/32" wide
SEES-ENFORCER-GIB-010	Replacement Door Gib, Nylon, 23/64" wide
SEES-ENFORCER-HDW	Bag Of 50 Mounting Screws for Enforcer Door Gib
SEES-ENFORCER-LP-R	SEES Safety Door Guide, Stainless Steel, Low Profile (Red) Adjustable guide, w/ 7/16" nylon gib

Features

- Manufactured in durable 304 Stainless Steel for 100% rust resistance
- Serrated grip locks into place and ensures stability
- Easy installation and field time savings with fully adjustable built in safety retainers and bar guides
- Engineered to greatly reduce risk of door and door sill dislodgment
- Versatile design fits most existing mounting holes
- Improved safety design addresses impact loads placed on lower elevator door
- Passed impact testing at 400ft-lbf
- Can handle 18,000 lbs of force



SEES-ENFORCER-GIB-001



SEES-ENFORCER-GIB-002



SEES-ENFORCER-GIB-003



SEES-ENFORCER-GIB-004



SEES-ENFORCER-010



SEES-ENFORCER-FT

Enforcer EDGE



SEES-ENFORCER-EDGE-G

SEES Enforcer EDGE

S.E.E.S. #	Description
SEES-ENFORCER-EDGE-G	SEES Safety Door Guide, Stainless Steel, 0"-1" Offset with Green 15/32" Gib
SEES-ENFORCER-EDGE-R	SEES Safety Door Guide, Stainless Steel, 0"-1" Offset with Red 7/16" Gib
SEES-ENFORCER-EDGE-W	SEES Safety Door Guide, Stainless Steel, 0"-1" Offset with White 1/2" Gib
SEES-ENFORCER-EDGE-B	SEES Safety Door Guide, Stainless Steel, 0"-1" Offset with Blue 17/32" Gib

■ Great for Westinghouse & Otis elevators with little to no offset

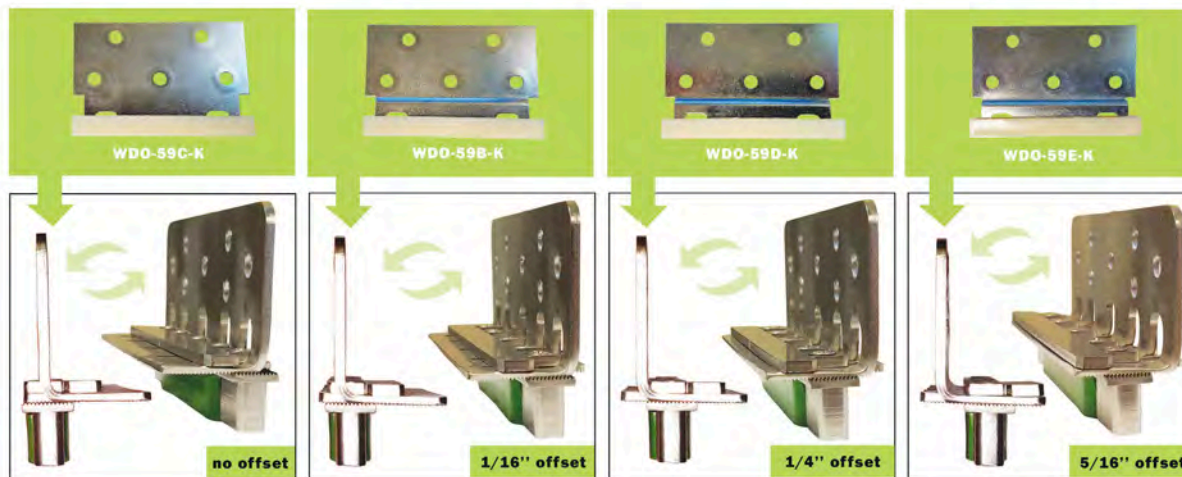

EPCO Door Gib Kits

S.E.E.S. #	O.E.M. #	Description
EPCO-GIB-BR	BR	Door Gib, Adjustable roller bearing
EPCO-GIB-C	C	Door Gib, Adjustable 15/32" W white nylon
EPCO-GIB-CD-3	CD-3	Door Gib & Chassis, 15/32" W white nylon with 1" W Chassis
EPCO-GIB-CD-4	CD-4	Door Gib & Chassis, 15/32" W white nylon with 1-1/8" W Chassis
EPCO-GIB-CD-5	CD-5	Door Gib & Chassis, 15/32" W white nylon with 1-1/4" W Chassis



EPCO-GIB-BR

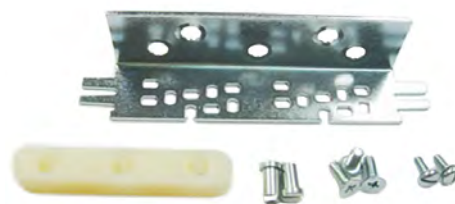

EPCO-GIB-CD-3

Door Gibs/Door Bumpers

EPCO Door Gib Kits

S.E.E.S #	O.E.M. #	Description
EPCO-GIB-D-3	D-3	Door Gib Chassis, 1" W adjustable bracket
EPCO-GIB-D-4	D-4	Door Gib Chassis, 1-1/8" W adjustable bracket
EPCO-GIB-D-5	D-5	Door Gib Chassis, 1-1/4" W adjustable bracket
EPCO-GIB-MG	MG	Door Gib, Adjustable 7/16" W black nylon
EPCO-GIB-MGD-3	MGD-3	Door Gib & Chassis, 7/16" W black nylon with 1" W Chassis
EPCO-GIB-MGD-4	MGD-4	Door Gib & Chassis, 7/16" W black nylon with 1-1/4" W Chassis
EPCO-GIB-MGD-5	MGD-5	Door Gib & Chassis, 7/16" W black nylon with 1-1/8" W Chassis
EPCO-GIB-S	S	Door Gib, Adjustable 23/64" W yellow nylon
EPCO-GIB-SD-3	SD-3	Door Gib & Chassis, 23/64" W yellow nylon with 1" W Chassis
EPCO-GIB-SD-4	SD-4	Door Gib & Chassis, 23/64" W yellow nylon with 1-1/4" W Chassis
EPCO-GIB-SD-5	SD-5	Door Gib & Chassis, 23/64" W yellow nylon with 1-1/8" W Chassis
EPCO-GIB-T	T	Door Gib, Adjustable 1/2" W blue nylon
EPCO-GIB-TD-3	TD-3	Door Gib & Chassis, 1/2" W blue nylon with 1" W Chassis
EPCO-GIB-TD-4	TD-4	Door Gib & Chassis, 1/2" W blue nylon with 1-1/8" W Chassis
EPCO-GIB-TD-5	TD-5	Door Gib & Chassis, 1/2" W blue nylon with 1-1/4" W Chassis
EPCO-GIB-Z4	Z 4	Gib Bracket, 4Z bracket, 3/8" offset

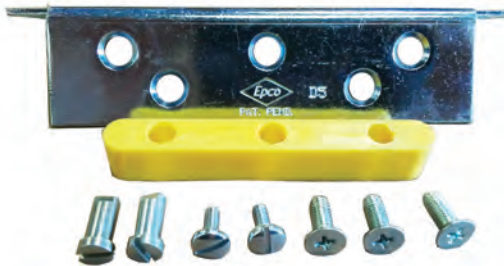

EPCO-GIB-SD-5

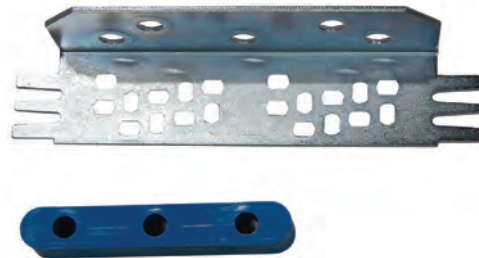

EPCO-GIB-TD-4



EPCO-GIB-TD-5



EPCO-GIB-Z4



MIS-146



MIS-146B

Door Gibs and Gib Kits

S.E.E.S. #	Description
MIS-146	Gib Kit , 15/32", includes bracket (4-1/2"), gib (Green, 2-3/4" L) and hardware. Two fire tabs. Replacement gib MIS-146A
MIS-146A	Gib , Nylon, 15/32", Green replacement gib
MIS-146B	Gib Kit , 15/32", Heavy Duty, includes bracket, gib (Green, 2-3/4" L) and hardware. Three fire tabs. Replacement gib MIS-146A
MIS-146C	Gib Kit , 1/2", includes bracket, gib (White, 2-3/4" L) and hardware. Three fire tabs. Replacement gib MIS-146H
MIS-146H	Gib , Nylon, 1/2", White replacement gib
MIS-146F	Gib Kit , 7/16", includes bracket, gib (Red, 2-3/4" L) and hardware. Three hole mount. Replacement gib MIS-146G
MIS-146G	Gib , Nylon, 7/16", Red replacement gib
MIS-146-GG	Gib , replacement for A90, Door Gib Assy
MIS-146L-SS	Gib , Fire Tab 3/4" Offset, Stainless Steel
MIS-146D	Gib , Nylon, 7/16" sill slot width, 2 hole mount
MIS-146M	Gib Kit , 17/32", includes bracket, gib (Blue 2-3/4") and hardware. Two Fire Tabs. Replacement gib MIS-146I
MIS-146I	Gib , Nylon, 17/32", Blue replacement gib
MIS-146-FTB	Gib , Fire Tab Bracket for MIS-146 Series



MIS-146C



MIS-146F



MIS-146M

S.E.E.S. #	O.E.M. #	Description
MIS-146J	2976	Door Gib , Fire Tab kit, for 1/2" off set, 4" L, bracket and screws included
MIS-146K	2977	Door Gib , Fire Tab kit, for 5/8" off set, 4" L, bracket and screws included
MIS-146L		Door Gib , Fire Tab kit, 3/4" offset, 4" L, bracket and screws included
MIS-146J-NY	2926	Door Gib , Fire Tab, 1/2" Offset NY 10GA, 4" Long, with hardware
MIS-146K-NY	2927	Door Gib , Fire Tab, 5/8" Offset NY 10GA, 4" Long, with hardware
MIS-146L-NY	2920	Door Gib , Fire Tab, 3/4" Offset NY 10GA, 4" Long, with hardware
MIS-146N	2982	Door Gib , Fire Tab kit, 1/4" offset, 4" Long, with hardware
MIS-146P	2983	Door Gib , Fire Tab kit, 3/8" offset, 4" Long, with hardware
MIS-146Q	2979	Door Gib , Fire Tab kit, 7/8" offset, 4" Long, with hardware
MIS-146Q-NY	2929	Door Gib , Fire Tab, 7/8" Offset NY 10GA, 4" Long, with hardware
MIS-146R	2978	Door Gib , Fire Tab kit, 1" offset, 4" Long, with hardware
MIS-146R-NY	2928	Door Gib , Fire Tab, 1" Offset NY 10GA, 4" Long, with hardware
MIS-TYL-006		Door Gib , with mounting screw
MIS-TYL-006A		Door Gib , with brass insert & mounting screw
MIS-TYL-007		Door Gib Kit , gib, bracket & hardware



MIS-146-GG



MIS-146J



MIS-146K



MIS-146Q



MIS-146R

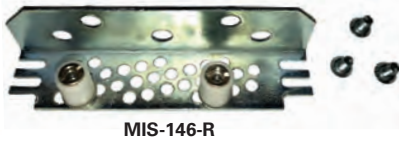

MIS-146-R



MIS-146-R1

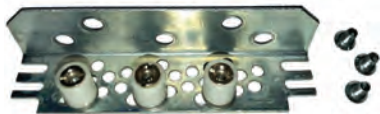

MIS-146-R2



MIS-146-R3



MIS-146C-R1



MIS-146C-R2



MIS-146C-R3



MIS-146F-R



MIS-146F-R2



MIS-146F-R3

Door Roller Guide Kits

S.E.E.S. #	O.E.M. #	Description
MIS-146-R	DWR-2	Door Roller Guide Kit, 15/32", 2 Rollers, Door < or = 1"
MIS-146-R1	DLR-2	Door Roller Guide Kit, 15/32", 2 Rollers, Door 1" - 1.25"
MIS-146-R2	DWRH-2	Door Roller Guide Kit, 15/32", 3 Rollers, Door < or = 1"
MIS-146-R3	DLRH-2	Door Roller Guide Kit, 15/32", 3 Rollers, Door 1" - 1.25"
MIS-146C-R	DWR-3	Door Roller Guide Kit, 1/2", 2 Rollers, Door < or = 1"
MIS-146C-R1	DLR-3	Door Roller Guide Kit, 1/2", 2 Rollers, Door 1" - 1.25"
MIS-146C-R2	DWRH-3	Door Roller Guide Kit, 1/2", 3 Rollers, Door < or = 1"
MIS-146C-R3	DLRH-3	Door Roller Guide Kit, 1/2", 3 Rollers, Door 1" - 1.25"
MIS-146F-R	DWR-1	Door Roller Guide Kit, 7/16", 2 Rollers, Door < or = 1"
MIS-146F-R1	DLR-1	Door Roller Guide Kit, 7/16", 2 Rollers, Door 1" - 1.25"
MIS-146F-R2	DWRH-1	Door Roller Guide Kit, 7/16", 3 Rollers, < OR = 1"
MIS-146F-R3	DLRH-1	Door Roller Guide Kit, 7/16", 3 Rollers, 1" - 1.25"

Door Bumpers



MIS-157



MIS-157A

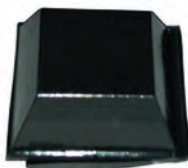

MIS-157B



MIS-157C

S.E.E.S. #	O.E.M. #	Description
MIS-157		Door Bumper, 1" O.D. x 1/2" Diameter, threaded stem
MIS-157A		Door Bumper, 1-1/4" square, self adhesive
MIS-157B		Door Bumper, 13/16" square x 1/4" thick, self adhesive, pack of 36
MIS-157C	G30B1	Door Bumper, Rubber 7/16" O.D. x 1/8" I.D. x 3/8" Long
MIS-157-HDW		Speed Nut for MIS-157, Bag of 10



Get your ZZZ's with SEES!

Please visit us in
Atlantic City at
Booth #1705!

Rest easy knowing your elevator door is
secure with SEES Z-Brackets.



Ask About Our Poly-Coated
Sill Saver Z Brackets!

S.E.E.S. #	Description
SEES-FTZB-001	SEES FireTab Z-Bracket, 1/4" Offset, 8" lg, 11GA Galv Steel
SEES-FTZB-002	SEES FireTab Z-Bracket, 3/8" Offset, 8" lg, 11GA Galv Steel
SEES-FTZB-003	SEES FireTab Z-Bracket, 1/2" Offset, 8" lg, 11GA Galv Steel
SEES-FTZB-004	SEES FireTab Z-Bracket, 5/8" Offset, 8" lg, 11GA Galv Steel
SEES-FTZB-005	SEES FireTab Z-Bracket, 9/16" Offset, 8" lg, 11GA Galv Steel
SEES-FTZB-006	SEES FireTab Z-Bracket, 3/4" Offset, 8" lg, 11GA Galv Steel
SEES-FTZB-007	SEES FireTab Z-Bracket, 7/8" Offset, 8" lg, 11GA Galv Steel
SEES-FTZB-008	SEES FireTab Z-Bracket, 1" Offset, 8" lg, 11GA Galv Steel
SEES-FTZB-009	SEES FireTab Z-Bracket, 1-1/4" Offset, 8" lg, 11GA Galv Steel
SEES-FTZB-010	SEES FireTab Z-Bracket, 1-1/2" Offset, 8" lg, 11GA Galv Steel
SEES-FTZB-011	SEES FireTab Z-Bracket, 1-5/8" Offset, 8" lg, 11GA Galv Steel

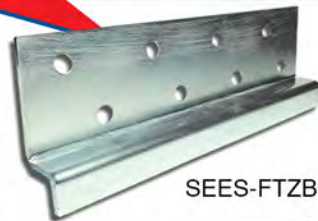

SEES-FTZB-004

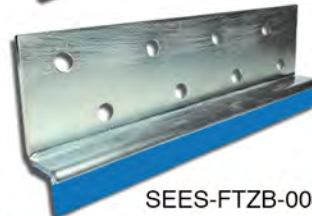

SEES-FTZB-004-P

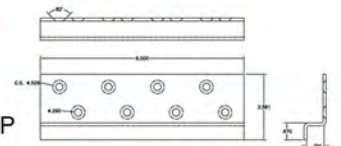

Always Smooth Sailing



Fire Tabs / Z Brackets

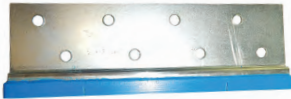

SEES-FTZB-001-P



SEES-FTZB-002-P



SEES-FTZB-003-P



SEES-FTZB-003-AP



SEES-FTZB-004-P



SEES-FTZB-012-A

S.E.E.S. #	Description
SEES-FTZB-000	SEES FireTab Z-Bracket, 0" Offset, 8" lg, 11GA Galv Steel
SEES-FTZB-000-P*	SEES Poly Z-Bracket, 0" Offset 8" lg, 11GA with Poly, poly width: 1/4"
SEES-FTZB-001	SEES FireTab Z-Bracket, 1/4" Offset, 8" lg, 11GA Galv Steel
SEES-FTZB-001-P*	SEES Poly Z-Bracket, 1/4" Offset, 8" lg, 11GA Galv Steel Poly, poly width: 1/4"
SEES-FTZB-001SS	SEES FireTab Z-Bracket, 1/4" Offset, 8" lg, 11GA 304 Stainless Steel
SEES-FTZB-001SS-B	SEES FireTab Z-Bracket, 1/4" Offset, 304SS
SEES-FTZB-002	SEES FireTab Z-Bracket, 3/8" Offset, 8" lg, 11GA Galv Steel
SEES-FTZB-002-P*	SEES Poly Z-Bracket, 3/8" Offset, 8" lg, 11GA Galv Steel Poly, poly width: 1/4"
SEES-FTZB-002SS	SEES FireTab Z-Bracket, 3/8" Offset, 8" lg, 11GA 304 Stainless Steel
SEES-FTZB-003	SEES FireTab Z-Bracket, 1/2" Offset, 8" lg, 11GA Galv Steel
SEES-FTZB-003-A	SEES FireTab Z-Bracket, 1/2" Offset, 4" lg 11GA Galv Steel
SEES-FTZB-003-AP	SEES FireTab Z-Bracket, 1/2" Offset, 4" lg 11GA Galv Steel, with Poly Guide, poly width: 1/4"
SEES-FTZB-003-P*	SEES Poly Z-Bracket, 1/2" Offset, 8" lg, 11GA Galv Steel Poly, poly width: 1/4"
SEES-FTZB-003SS	SEES FireTab Z-Bracket, 1/2" Offset, 8" lg, 11GA 304 Stainless Steel
SEES-FTZB-004	SEES FireTab Z-Bracket, 5/8" Offset, 8" lg, 11GA Galv Steel
SEES-FTZB-004-P*	SEES Poly Z-Bracket, 5/8" Offset, 8" lg, 11GA Galv Steel Poly, poly width: 1/4"
SEES-FTZB-004SS	SEES FireTab Z-Bracket, 5/8" Offset, 8" lg, 11GA 304 Stainless Steel
SEES-FTZB-005	SEES FireTab Z-Bracket, 9/16" Offset, 8" lg, 11GA Galv Steel, poly width: 1/4"
SEES-FTZB-005-P*	SEES Poly Z-Bracket, 9/16" Offset, 8" lg, 11GA Galv Steel Poly, poly width: 1/4"
SEES-FTZB-005SS	SEES FireTab Z-Bracket, 9/16" Offset, 8" lg, 11GA 304 Stainless Steel
SEES-FTZB-006	SEES FireTab Z-Bracket, 3/4" Offset, 8" lg, 11GA Galv Steel
SEES-FTZB-006-P*	SEES Poly Z-Bracket, 3/4" Offset, 8" lg, 11GA Galv Steel Poly, poly width: 1/4"
SEES-FTZB-006SS	SEES FireTab Z-Bracket, 3/4" Offset, 8" lg, 11GA 304 Stainless Steel
SEES-FTZB-007	SEES FireTab Z-Bracket, 7/8" Offset, 8" lg, 11GA Galv Steel
SEES-FTZB-007-A	SEES FireTab Z-Bracket, 7/8" Offset, 4" lg, 11GA Galv Steel
SEES-FTZB-007-P*	SEES Poly Z-Bracket, 7/8" Offset, 8" lg, 11GA Galv Steel Poly, poly width: 1/4"
SEES-FTZB-007SS	SEES FireTab Z-Bracket, 7/8" Offset, 8" lg, 11GA 304 Stainless Steel
SEES-FTZB-008	SEES FireTab Z-Bracket, 1" Offset, 8" lg, 11GA Galv Steel
SEES-FTZB-008-P*	SEES Poly Z-Bracket, 1" Offset, 8" lg, 11GA Galv Steel Poly, poly width: 1/4"
SEES-FTZB-008SS	SEES FireTab Z-Bracket, 1" Offset, 8" lg, 11GA 304 Stainless Steel
SEES-FTZB-009	SEES FireTab Z-Bracket, 1-1/4" Offset, 8" lg, 11GA Galv Steel
SEES-FTZB-009-P*	SEES Poly Z-Bracket, 1-1/4" Offset, 8" lg, 11GA Galv Steel Poly, poly width: 1/4"
SEES-FTZB-009SS	SEES FireTab Z-Bracket, 1-1/4" Offset, 8" lg, 11GA 304 Stainless Steel
SEES-FTZB-010	SEES FireTab Z-Bracket, 1-1/2" Offset, 8" lg, 11GA Galv Steel
SEES-FTZB-010-P*	SEES Poly Z-Bracket, 1-1/2" Offset, 8" lg, 11GA Galv Steel Poly, poly width: 1/4"
SEES-FTZB-010SS	SEES FireTab Z-Bracket, 1-1/2" Offset, 8" lg, 11GA 304 Stainless Steel
SEES-FTZB-011	SEES FireTab Z-Bracket, 1-5/8" Offset, 8" lg, 11GA Galv Steel
SEES-FTZB-011-P*	SEES Poly Z-Bracket, 1-5/8" Offset, 8" lg, 11GA Galv Steel Poly, poly width: 1/4"
SEES-FTZB-011SS	SEES FireTab Z-Bracket, 1-5/8" Offset, 8" lg, 11GA 304 Stainless Steel
SEES-FTZB-012-A	SEES FireTab Z-Bracket, 1-1/8" Offset, 4" lg 11GA Galv Steel with Hdw

* Poly Thickness: .250"

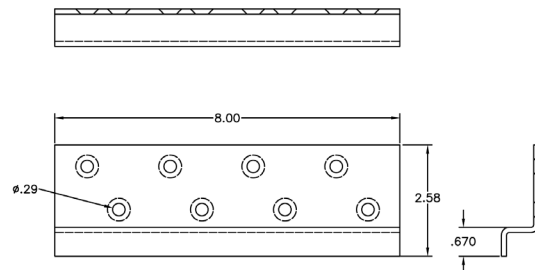
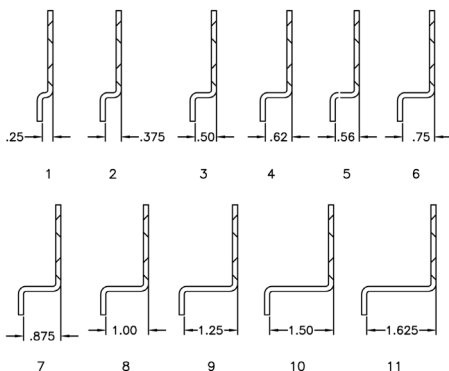

Platform Guards / Toe Guards

S.E.E.S. #	Description
SEES-PTG-36-026	Guard, Platform/Toe/Apron for 36" opening, Actual 36" x 26", Guard Only
SEES-PTG-36-036	Guard, Platform/Toe/Apron for 36" opening, Actual 38" x 36"
SEES-PTG-36-038	Guard, Platform/Toe/Apron for 36" opening, Actual 38" x 38"
SEES-PTG-36-040	Guard, Platform/Toe/Apron for 36" opening, Actual 38" x 40"
SEES-PTG-36-042	Guard, Platform/Toe/Apron for 36" opening, Actual 38" x 42"
SEES-PTG-36-044	Guard, Platform/Toe/Apron for 36" opening, Actual 38" x 44"
SEES-PTG-36-046	Guard, Platform/Toe/Apron for 36" opening, Actual 38" x 46"
SEES-PTG-36-048	Guard, Platform/Toe/Apron for 36" opening, Actual 38" x 48"
SEES-PTG-42-021	Guard, Platform/Toe/Apron for 42" Opening, Actual 44" x 21"
SEES-PTG-42-028	Guard, Platform/Toe/Apron for 42" opening, Actual 42" x 28", Guard Only
SEES-PTG-42-036	Guard, Platform/Toe/Apron for 42" opening, Actual 44" x 36"
SEES-PTG-42-038	Guard, Platform/Toe/Apron for 42" opening, Actual 44" x 38"
SEES-PTG-42-040	Guard, Platform/Toe/Apron for 42" opening, Actual 44" x 40"
SEES-PTG-42-042	Guard, Platform/Toe/Apron for 42" opening, Actual 44" x 42"
SEES-PTG-42-044	Guard, Platform/Toe/Apron for 42" opening, Actual 44" x 44"
SEES-PTG-42-046	Guard, Platform/Toe/Apron for 42" opening, Actual 44" x 46"
SEES-PTG-42-048	Guard, Platform/Toe/Apron for 42" opening, Actual 44" x 48"
SEES-PTG-48-036	Guard, Platform/Toe/Apron for 48" opening, Actual 50" x 36"
SEES-PTG-48-038	Guard, Platform/ Toe/ Apron for 48" opening, Actual 50" x 38"
SEES-PTG-48-040	Guard, Platform/Toe/Apron for 48" opening, Actual 50" x 40"
SEES-PTG-48-042	Guard, Platform/Toe/Apron for 48" opening, Actual 50" x 42"
SEES-PTG-48-044	Guard, Platform/Toe/Apron for 48" opening, Actual 50" x 44"
SEES-PTG-48-046	Guard, Platform/Toe/Apron for 48" opening, Actual 50" x 46"
SEES-PTG-48-048	Guard, Platform/Toe/Apron for 48" opening, Actual 50" x 48"
SEES-PTG-54-048	Guard, Platform/Toe/Apron for 54" opening, Actual 56" x 48"
SEES-PTG-STRUT	Strut, Arms and platform guard with hardware
SEES-RTG-036-48	Guard, Retractable Toe Guard, 36" W x 48" L Retracts 15"
SEES-RTG-042-48	Guard, Retractable Toe Guard, 42" W x 48" L Retracts 15"
SEES-RTG-046-48	Guard, Retractable Toe Guard, 46" W x 48" L Retracts 15"
SEES-RTG-048-48	Guard, Retractable Toe Guard, 48" W x 48" L Retracts 15"
SEES-RTG-050-48	Guard, Retractable Toe Guard, 50" W x 48" L Retracts 15"



SEES-PTG-42-042



SEES-PTG-STRUT

Door Wedge Tools

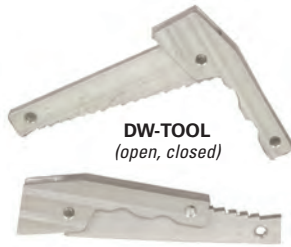

S.E.E.S. #	O.E.M. #	Description
DW-TOOL	10-850	Door Wedge Tool
MIS-DW-T1	SAF165/MT-114390-9	Door Wedge Tool, with Knob and fire tab slots
MIS-DW-T2	SAF164/MT-114390-8	Door Wedge Tool, with Knob standard without slot
MIS-DW-T3	10-851	Door Wedge Tool, with Knob, narrow door stop, 3/8" wide
SEES-DWT-001		SEES Door Wedge Tool, Blue Poly
SEES-DWT-002		SEES Door Wedge Tool, Black Poly
SEES-DWT-003		SEES Door Wedge Tool, Blue Poly with fire tab slot
SEES-DWT-004		SEES Door Wedge Tool, Black Poly with fire tab slot
SEES-DWT-004R		SEES Door Wedge Tool, Rubber 70 Duro with fire tab slot
SEES-DWT-005		SEES Spring Door Wedge Tool, Rubber Coated Spring Steel
SEES-DWT-006		SEES Door Wedge Tool, Stainless Steel Bottle Opener
DG-MT		Door Gap, Measuring tool
KOOL-KP5005		Sill Height Gauge, Metric, stainless steel



MIS-DW-T1



MIS-DW-T2



SEES-DWT-001



SEES-DWT-002



SEES-DWT-003



SEES-DWT-004



SEES-DWT-004R



SEES-DWT-005



SEES-DWT-006



DG-MT

Hatch Sills

S.E.E.S. #	O.E.M. #	Description
MIS-SILL-BRKT-001		Sill Mounting Bracket, with hardware



MIS-SILL-BRKT-001

S.E.E.S. #	O.E.M. #	Description
MIS-SILL-101	HS1S/8	Hatch Sill, Single Speed, Aluminum, 8ft
MIS-SILL-101A	HS1S/16	Hatch Sill, Single Speed, Aluminum, 16ft

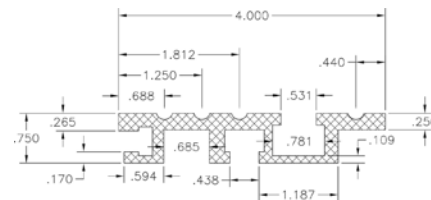

MIS-SILL-101

S.E.E.S. #	O.E.M. #	Description
MIS-SILL-102	HS2S/8	Hatch Sill, Two Speed, Aluminum, 8ft
MIS-SILL-102A	HS2S/16	Hatch Sill, Two Speed, Aluminum, 16ft

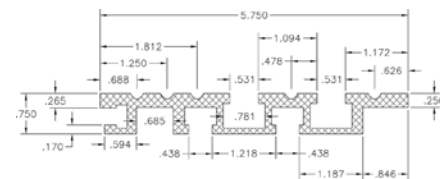

MIS-SILL-102

S.E.E.S. #	O.E.M. #	Description
MIS-SILL-SPECIAL		Sill, Single or Two Speed Cut to Size

Car Sills

S.E.E.S. #	O.E.M. #	Description
MIS-SILL-201	CS1S/8	Car Sill, Single Speed, Aluminum, 8ft
MIS-SILL-201A	CS1S/16	Car Sill, Single Speed, Aluminum, 16ft

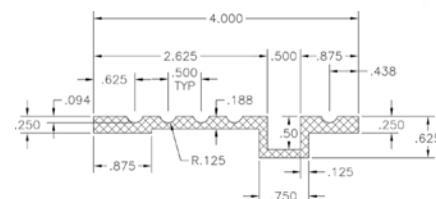

MIS-SILL-201

S.E.E.S. #	O.E.M. #	Description
MIS-SILL-202	CS2S/8	Car Sill, Two Speed, Aluminum, 8ft
MIS-SILL-202A	CS2S/16	Car Sill, Two Speed, Aluminum, 16ft

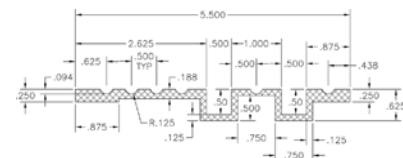

MIS-SILL-202

S.E.E.S. #	O.E.M. #	Description
MIS-SILL-210	CS1S/C	Car Sill, Single Speed, Center, Aluminum, 7ft

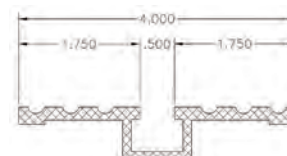

MIS-SILL-210

Tools for Sills

S.E.E.S. #	Description
MIS-TOOL-003	Step Drill Bits, high speed steel, 10 hole sizes range from minimum 13/16" to maximum 1-3/8". Shank size 7/16"
MIS-TOOL-202	Sill Height Gauge, Imperial Slider Ruler
MIS-TOOL-202M	Sill Height Gauge, Metric Slider Ruler
MIS-TOOL-203	Sill Height Gauge, Imperial, S/S Slider
MIS-TOOL-203M	Sill Height Gauge, Metric, S/S Slider

Pull Chain Door Locks

S.E.E.S. #	Description
MIS-189P-A	Courion pull chain door lock assembly, with keyless pipe



MIS-189P-A

Doors for Residential Elevators

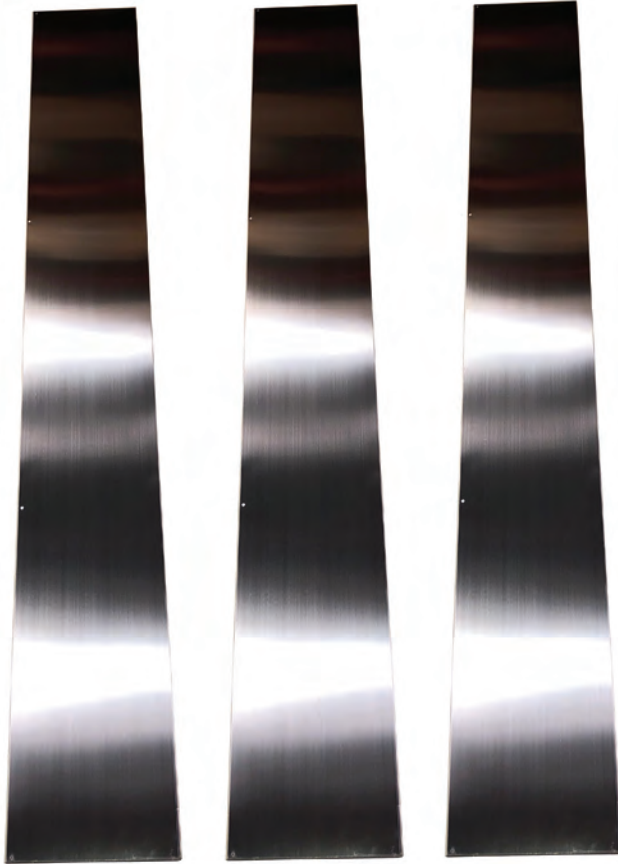

SEES-HL-LD-95X36-SS-001R

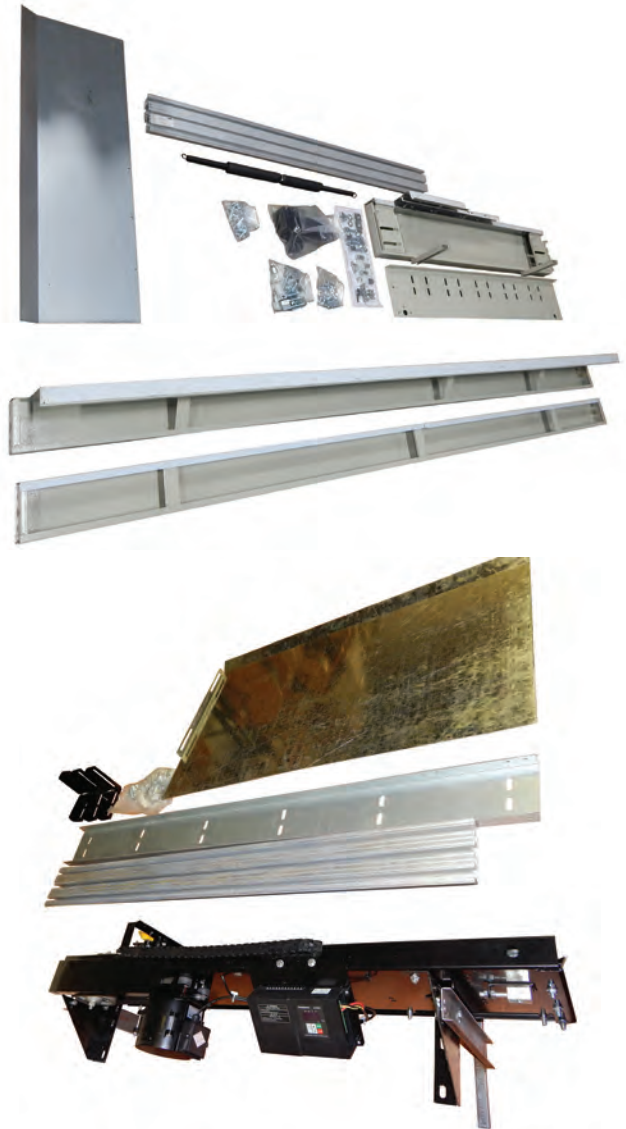

Doors for Residential Elevators

S.E.E.S. #	Description
SEES-HL-CD-83X36-GL-001R	Door Oper and Car Door, 3 Pane glass RH with 83" x 36" (2100mm x 900mm)
SEES-HL-CD-83X36-SS-001L	Door Oper and Car Door, 3 Pane SS LH with 83" x 36" (2100mm x 900mm)
SEES-HL-CD-83X36-SS-001R	Door Oper and Car Door, 3 Pane SS RH with 83" x 36" (2100mm x 900mm)
SEES-HL-CD-95X36-GL-001L	Door Oper and Car Door, 3 Pane glass LH with 95" x 36" (2400mm x 900mm)
SEES-HL-CD-95X36-GL-001R	Door Oper and Car Door, 3 Pane glass RH with 95" x 36" (2400mm x 900mm)
SEES-HL-CD-95X36-SS-001L	Door Oper and Car Door, 3 Pane SS LH with 95" x 36" (2400mm x 900mm)
SEES-HL-CD-95X36-SS-001R	Door Oper and Car Door, 3 Pane SS RH with 95" x 36" (2400mm x 900mm)
SEES-HL-CD-83X36-GL-001L	Door Oper and Car Door, 3 Pane glass LH with 83" x 36" (2100mm x 900mm)
SEES-HL-LD-83X36-GL-001L	Landing Door, 3 Panel glass LH with 83" x 36" (2100mm x 900mm)
SEES-HL-LD-83X36-GL-001R	Landing Door, 3 Panel glass RH with 83" x 36" (2100mm x 900mm)
SEES-HL-LD-83X36-SS-001L	Landing Door, 3 Panel SS LH with 83" x 36" (2100mm x 900mm)
SEES-HL-LD-83X36-SS-001R	Landing Door, 3 Panel SS RH with 83" x 36" (2100mm x 900mm)
SEES-HL-LD-95X36-GL-001L	Landing Door, 3 Panel glass LH with 95" x 36" (2400mm x 900mm)
SEES-HL-LD-95X36-GL-001R	Landing Door, 3 Panel glass RH with 95" x 36" (2400mm x 900mm)
SEES-HL-LD-95X36-SS-001L	Landing Door, 3 Panel SS LH with 95" x 36" (2400mm x 900mm)
SEES-HL-LD-95X36-SS-001R	Landing Door, 3 Panel SS RH with 95" x 36" (2400mm x 900mm)

Doors

Cab Door Features

- Doors are available in single-speed side slide, center-opening, two-speed side slide configurations
- Various door widths and heights are available to accommodate your project's needs
- Doors finish is stainless steel brushed (#4 finish) on 20 gauge material
- Doors are rated for 90 minutes fire resistance and UL Labeled accordingly



SEES-CAB-36-84-SS-R



SEES-CAB-42-84-CP



SEES-CAB-36-84-2SP-R

Cab Doors

S.E.E.S. #	Hand	Speed	Opening	Height	Hanger Mounting Hole Dimensions	Material/Finish
SEES-CAB-48-84-2S-L-S	Left	Double	24"	84"	4.125" Slow Door Only	Stainless Veneer
SEES-CAB-34-84-SS-R	Right	Single	34"	84"	4.125"	Stainless Veneer
SEES-CAB-36-84-SS-R	Right	Single	36"	84"	4.125"	Stainless Veneer
SEES-CAB-36-84-SS-L	Left	Single	36"	84"	4.125"	Stainless Veneer
SEES-CAB-36-84-2SP-R	Right	Two	36"	84"	4.125"	Stainless Veneer
SEES-CAB-36-84-2SP-L	Left	Two	36"	84"	4.125"	Stainless Veneer
SEES-CAB-36-84-CP-5WL	Left	Single	36"	84"	4.125"	5WL Stainless Steel
SEES-CAB-36-84-SS-L-M	Left	Single	36"	84"	4.125"	Muntz Veneer
SEES-CAB-36-84-SS-L-OTI-INTGRL	Left	Single	36"	84"	4.125" w/ Otis Integral Hangers	Stainless Veneer
SEES-CAB-36-84-SS-R-OTI-INTGRL	Right	Single	36"	84"	4.125" w/ Otis Integral Hangers	Stainless Veneer
SEES-CAB-36-84-SS-L-OTIS	Left	Single	36"	84"	4.125"	Stainless Veneer
SEES-CAB-36-84-SS-L-SPECIAL	Left	Single	36"	84"	4.125"	Stainless Veneer
SEES-CAB-36-84-SS-R-SPECIAL	Right	Single	36"	84"	4.125"	Stainless Veneer
SEES-CAB-36-84-SS-R-WIN	Right	Single	36"	84"	4.125" w/ Window - SPECIAL	Stainless Veneer
SEES-CAB-40-84-2SP-L-BB	Left	Two	40"	84"	4.125"	#4 Brushed Brass
SEES-CAB-40-84-CP	Center	Single	40"	84"	4.125"	Stainless Veneer
SEES-CAB-42-84-CP-5WL	Right	Single	40"	84"	4.125" w/ Window - SPECIAL	Stainless Veneer
SEES-CAB-42-84-CP	Center	Single	42"	84"	4.125"	Stainless Veneer
SEES-CAB-42-84-SS-R	Right	Single	42"	84"	4.125"	Stainless Veneer
SEES-CAB-42-84-SS-L	Left	Single	42"	84"	4.125"	Stainless Veneer
SEES-CAB-42-88.75-SS-L	Left	Single	42"	88.75"		Stainless Veneer
SEES-CAB-42-84-2SP-L	Left	Two	42"	84"	4.125"	Stainless Veneer
SEES-CAB-43.5-84.25-SS-R	Right	Single	42"	84.25"	Not Drilled	Stainless
SEES-CAB-43.5-84.25-SS-L	Right	Single	42"	84.25"	Not Drilled	Stainless
SEES-CAB-44-84-2SP-L	Left	Two	44"	84"	4.125"	Stainless Veneer
SEES-CAB-42-84-2SP-R	Right	Two	42"	84"	4.125"	Stainless Veneer
SEES-CAB-42-84-2SP-L	Left	Two	42"	84"	4.125"	Stainless Veneer
SEES-CAB-46-84-2SP-L	Left	Two	42"	84"	4.125"	Stainless Veneer
SEES-CAB-46-84-2SP-R	Right	Two	42"	84"	4.125"	Stainless Veneer

Cab Doors



SEES-CAB-34-84-SS-R



SEES-CAB-54-84-2S-CP



SEES-CAB-54-84-2S-RH

S.E.E.S. #	Hand	Speed	Opening	Height	Hanger Mounting Hole Dimensions	Material/Finish
SEES-CAB-42-84-CP-6940	Center	Single	42"	84"	4.125" GAL Hangers and Otis 6940 Locks	Stainless Veneer
SEES-CAB-42-84-CP-CA-M	Center	Single	42"	84"	4.125"	Stainless Veneer
SEES-CAB-42-84-CP-M	Center	Single	42"	84"	4.125"	Stainless Veneer
SEES-CAB-42-84-CP-MAC	Center	Single	42"	84"	4.125"	Stainless Veneer
SEES-CAB-42-84-CP-OTIS-6940	Center	Single	42"	84"	4.125"	Stainless Veneer
SEES-CAB-42-84-SS-L-OTIS	Left	Single	42"	84"	4.125"	Stainless Veneer
SEES-CAB-42-89.5-SS-R	Right	Single	42"	84"	4.125"	Stainless Veneer
SEES-CAB-43.5-83.25-SS-L-BLANK	Left	Single	43.5"	83.25"	Not Drilled	Stainless
SEES-CAB-44-84-SS-CP	Center	Single	44"	84"	4.125"	Stainless Veneer
SEES-CAB-44-84-SS-CP-A	Center	Single	44"	84"	4.125" Top Hole Only	Stainless Veneer
SEES-CAB-46-84-2S-CP	Center	Double	46"	84"	4.125"	Stainless Veneer
SEES-CAB-48-84-CP-SCH	Left		48"	84"	Drilled for Schindler	Stainless Veneer
SEES-CAB-48-84-2S-L	Left	Two	48"	84"	4.125"	Stainless Veneer
SEES-CAB-48-103-SS-CP-M	Center	Single	48"	103"	4.125"	Mirrored Stainless Steel
SEES-CAB-48-84-2S-R	Right	Two	48"	84"	4.125"	Stainless Veneer
SEES-CAB-48-84-2S-R-SPO-BLANK	Right	Two	48"	84"	Not Drilled, with Spec.	Dims
SEES-CAB-48-84-2S-L-BLANK	Left	Two	48"	84"	No Holes	Stainless Veneer
SEES-CAB-48-84-2S-CP	Center	Two	48"	84"	4.125"	Stainless Veneer
SEES-CAB-48-84-2S-R-6940	Right	Double	48"	84"	4.125" GAL Hangers and 6940 Lock	Stainless Veneer
SEES-CAB-48-84-2S-R-OTIS-6940	Right	Double	48"	84"	4.125" with Otis 6940 Lock	Stainless Veneer
SEES-CAB-48-84-SS-CP	Center	Single	48"	84"	4.125"	Stainless Veneer
SEES-CAB-48-96-2S-L	Left	Double	48"	96"	4.125"	Stainless Veneer
SEES-CAB-52-84-2S-LH	Left	Double	52"	84"	4.125"	Stainless Veneer
SEES-CAB-52-84-2S-RH	Right	Double	52"	84"	4.125"	Stainless Veneer
SEES-CAB-54-84-2S-CP	Center	Double	54"	84"	4.125"	Stainless Veneer
SEES-CAB-54-84-2S-LH	Left	Double	54"	84"	4.125"	Stainless Veneer
SEES-CAB-54-84-2S-RH	Right	Double	54"	84"	4.125"	Stainless Veneer
SEES-CAB-54-90-SS-CP	Center	Single	54"	90"	4.125"	Stainless Veneer
SEES-CAB-54-84-2S-RH	Right	Two	54"	84"	4.125"	Stainless Veneer
SEES-CAB-54-84-2S-CP	Center	Two	54"	84"	4.125"	Stainless Veneer
SEES-CAB-54-84-2S-LH	Left	Two	54"	84"	4.125"	Stainless Veneer
SEES-CAB-CP-SPECIAL	Center	Per Spec				

Door Features

- Doors are available in single-speed side slide, center-opening, two-speed side slide configurations
- Various door widths and heights are available to accommodate your project's needs
- Doors finish is stainless steel brushed (#4 finish) on 20 gauge material
- Doors are rated for 90 minutes fire resistance and UL Labeled accordingly

Hall / Entrance

S.E.E.S. #	Hand	Speed	Opening	Height	Hanger Mounting Hole Dimensions	Material/Finish
SEES-ENT-36-84-CP	Center	Single	36"	84"	4.125"	Stainless Veneer
SEES-ENT-36-84-SS-R-OTI-INTGRL	Right	Single	36"	84"	4.125", w/ Otis Integral Hangers	Stainless Veneer
SEES-ENT-36-84-SS-L-OTI-INTGRL	Left	Single	36"	84"	4.125", w/ Otis Integral Hangers	Stainless Veneer
SEES-ENT-36-84-SS-L	Left	Single	36"	84"	4.125"	Stainless Veneer
SEES-ENT-36-84-SS-R	Right	Single	36"	84"	4.125"	Stainless Veneer
SEES-ENT-36-84-SS-L-CA	Left	Single	36"	84"	4.125" H w/o Escutcheon Holes	Stainless Veneer
SEES-ENT-36-84-SS-R-CA	Right	Single	36"	84"	4.125" H w/o Escutcheon Holes	Stainless Veneer
SEES-ENT-36-84-SS-L-THY	Left	Single	36"	84"	4.125"	Stainless Veneer
SEES-ENT-36-84-SS-L-TKE	Left	Single	36"	84"	4.125" Drilled for TKE	Stainless Veneer
SEES-ENT-36-84-SS-L-WHITE	Left	Single	36"	84"	4.125"	Painted White
SEES-ENT-36-84-2SP-L	Left	Two	36"	84"	4.125"	Stainless Veneer
SEES-ENT-36-84-2SP-R	Right	Two	36"	84"	4.125"	Stainless Veneer
SEES-ENT-36-84-2SP-L-BLACK	Left	Double	36"	84"	4.125"	Painted black
SEES-ENT-36-84-2SP-R-BLACK	Right	Double	36"	84"	4.125"	Painted black
SEES-HALL-40-84-2SP-L-BB	Left	Two	40"	84"	4.125"	#4 Brushed Brass
SEES-ENT-40.25-84-2SP-R	Right	Two	40.25"	84"	4.125"	Stainless Veneer
SEES-ENT-42-84-CP	Center	Single	42"	84"	4.125"	Stainless Veneer
SEES-ENT-42-84-CP-CA	Center	Single	42"	84"	4.125" H w/o Escutcheon Holes	Stainless Veneer
SEES-ENT-42-84-CP-CA-M	Center	Single	42"	84"	4.125" w/o Escutcheon Hole	Stainless Veneer
SEES-ENT-42-84-CP-OTIS-6940	Center	Single	42"	84"	4.125" Otis 6940 Locks and Hangers	Stainless Veneer
SEES-ENT-42-84-CP-6940	Center	Single	42"	84"	4.125" GAL Hangers and Otis 6940 Locks	Stainless Veneer
SEES-ENT-42-84-SS-L	Left	Single	42"	84"	4.125"	Stainless Veneer
SEES-ENT-42-84-SS-L-DVR	Left	Single	42"	84"	4.125"	#4 Stainless Steel
SEES-ENT-42-84-SS-L-THY	Left	Single	42"	84"	4.125" Drilled for TKE	Primed for Paint
SEES-ENT-42-84-SS-L-TKE	Left	Single	42"	84"	4.125" Drilled for TKE	Stainless Veneer
SEES-ENT-42-84-SS-R	Right	Single	42"	84"	4.125"	Stainless Veneer
SEES-ENT-42-84-SS-L-P4P	Left	Single	42"	84"	4.125"	Primed for Paint
SEES-ENT-42-84-SS-R-P4P	Right	Single	42"	84"	4.125"	Primed for Paint
SEES-ENT-42-84-SS-L-316	Left	Single	42"	84"	4.125" Galv. Core	#4 Brushed Brass
SEES-ENT-42-84-SS-R-316	Right	Single	42"	84"	4.125"	Stainless Veneer
SEES-ENT-42-84-SS-R-BLANK	Right	Single	42"	84"	No holes	Stainless Veneer
SEES-ENT-42-84-2SP-L	Left	Two	42"	84"	4.125"	Stainless Veneer
SEES-ENT-42-84-2SP-L-BLANK	Left	Two	42"	84"	No Holes	Stainless Veneer
SEES-ENT-42-84-2SP-R	Right	Two	42"	84"	4.125"	Stainless Veneer
SEES-ENT-42-107-CP	Center	Single	42"	107"	4.125", GAL, Left oriented	Stainless Veneer
SEES-ENT-OTIS-84-SS-RH	Right	Single	43-3/8"	84-1/2"	4.125"	Stainless Veneer



Hall / Entrance

S.E.E.S. #	Hand	Speed	Opening Height		Hanger Mounting Hole Dimensions	Material/Finish
SEES-ENT-48-84-SS-CP-DVR-INTGR	Center	Single	48"	84"	Dover Intgrl Hangers	Stainless Veneer
SEES-ENT-48-84-2S-CP	Center	Double	48"	84"	4.125"	Stainless Veneer
SEES-ENT-48-84-2S-CP-CA	Center	Double	48"	84"	4.125" w/o Escutcheon Holes	Stainless Veneer
SEES-ENT-46-84-2S-CP-P4P	Center	Double	46"	84"	4.125"	Primed for Paint
SEES-ENT-46-84-2S-L-P4P	Left	Double	46"	84"	4.125"	Primed for Paint
SEES-ENT-46-84-2S-R-P4P	Right	Double	46"	84"	4.125"	Primed for Paint
SEES-ENT-46-84-2SP-L	Left	Two	46"	84"	4.125"	Stainless Veneer
SEES-ENT-48-84-2S-R	Right	Double	48"	84"	4.125"	Stainless Veneer
SEES-ENT-48-84-2S-R-6940	Right	Double	48"	84"	4.125" GAL Hangers and Otis 6940 Locks	Stainless Veneer
SEES-ENT-48-84-2S-R-OTIS-6940	Right	Double	48"	84"	4.125" Otis 6940 Lock	Stainless Veneer
SEES-ENT-46-84-2SP-R	Right	Two	46"	84"	4.125"	Stainless Veneer
SEES-ENT-48-84-2SP-L	Left	Two	48"	84"	4.125"	Stainless Veneer
SEES-ENT-48-84-2SP-L-CA	Left	Single	48"	84"	4.125" H w/o Escutcheon Holes	Stainless Veneer
SEES-ENT-48-84-2SP-L-PACKAGE	Left	Double	48"	84"	4.125" Per Specs and Drawing	Stainless Veneer
SEES-ENT-48-84-2SP-L-THY	Left	Double	48"	84"	4.125" Thyssen Drilling	Stainless Veneer
SEES-ENT-48-84-2SP-R-THY	Right	Double	48"	84"	4.125" Thyssen Drilling	Stainless Veneer
SEES-ENT-48-84-2SP-RH-MAYO-OTI	Right	Two	48"	84"	Drilled for Otis	Stainless Steel
SEES-ENT-48-84-2SP-R-CA	Right	Single	48"	84"	4.125" H w/o Escutcheon Holes	Stainless Veneer
SEES-ENT-48-96-2S-L	Left	Double	48"	96"	4.125"	Stainless Veneer
SEES-JAMB-48-96-2SP-RH	Right	Two	48"	96"	No Holes	Stainless Veneer
SEES-ENT-52-84-2S-LH	Left	Double	52"	84"	4.125"	Stainless Veneer
SEES-ENT-52-84-2S-RH	Right	Double	52"	84"	4.125"	Stainless Veneer
SEES-ENT-54-84-2S-CP	Center	Two	54"	84"	4.125"	Stainless Veneer
SEES-ENT-54-84-2S-LH	Left	Two	54"	84"	4.125"	Stainless Veneer
SEES-ENT-54-84-2S-RH	Right	Two	54"	84"	4.125"	Stainless Veneer

Doors For California Only

S.E.E.S. #	Hand	Speed	Opening Height		Hanger Mounting Hole Dimensions	Material/Finish
SEES-ENT-42-84-2SP-R-CA	Right	Two	42"	84"	W/o Escutcheon Holes	Stainless Veneer
SEES-ENT-42-84-SS-R-CA	Right	Single	42"	84"	W/o Escutcheon Holes	Stainless Veneer
SEES-ENT-42-84-SS-L-CA	Left	Single	42"	84"	W/o Escutcheon Holes	Stainless Veneer
SEES-ENT-43.5-83.25-SS-L-CA-BL	Left	Single	43.5"	83.25"	Not Drilled, w/o Escutcheon Holes	Stainless Steel
SEES-ENT-43.5-83.25-SS-R-CA-BL	Right	Single	43.5"	83.25"	Not Drilled, w/o Escutcheon Holes	Stainless Steel
SEES-ENT-48-84-2SP-L-CA-BLANK	Left	Two	48"	84"	No Holes, w/o Escutcheon Holes	Stainless Veneer

Sight Guards

S.E.E.S. #	Description
SEES-ENT-52-84-2S-RH	Sight Guards, for SEES-ENT-48-84-2SP-L
SEES-ENT-SG-84-001	Sight Guards, for SEES-ENT-SG-84-001
SEES-ENT-SG-84-001	Sight Guards, Special Size

SEES GUARDIAN

HEAVY DUTY DOORS



**SEES
GUARDIAN**



BUY ONE DOOR

GET

**25%
OFF**

A DOOR KIT

HEAVY DUTY PROTECTION

- Protect passengers
- Enhance safety
- Save time and money
- Reduce call backs
- Made in U.S.A.
- Easy to install
- Bundled value

FEATURES

- UL Rated
- Stainless Steel (304 #4) Finish
- 14 Gauge on Back
- 16 Gauge on Front
- 14GA Reinforcing Ribs (4 to 6)
- Covers on Front and Back
- Fire-Rated to 90 Minutes

Hall Door Kit:

- 2 Enforcers
- 1 SmarTork Spirator
- 1 SmarTork Bracket
- 2 Restrictor Flags
- 1 Door Wedge Tool



Car Door Kit:

- 2 Enforcers
- 1 Restrictor Cam
- 1 Door Wedge Tool



THE SEES **RESTRICTOR**

The **Enforcer**

SMARTORK™

FORTIFIED DOORS FOR HEAVY DUTY SECURITY



@SEESinc



SEESinc.com/blogs



SEESinc

Always Smooth Sailing



Freight Straps

S.E.E.S. #	Description
MIS-105	Pull Strap, 30", for freight elevators
MIS-106	Pull Strap, 18", for freight elevators
MIS-107	Pull Strap, 24", for freight elevators
MIS-107A	Pull Strap, 36", for freight elevators
MIS-107B	Pull Strap, 48", for freight elevators
MIS-107C	Pull Strap, 60", for freight elevators
MIS-107D	Pull Strap, 72", for freight elevators
MIS-107F	Pull Strap, 96", for freight elevators



MIS-106

■ Extra durable with heavy duty rivets for mounting. Need a length other than what's listed? We'll custom make to your requirements.



MIS-107



MIS-107D

Galvanized Aircraft Cable

S.E.E.S. #	Description
MIS-300	Aircraft Cable, 1/8" Galvanized steel cable cut to your specified length. Can be used as a selector cable
MIS-300-PVC	Aircraft Cable, 1/8" Galvanized steel cable as above, but PVC coated to 3/16"
MIS-300A	Aircraft Cable, 3/32" Galvanized steel cable cut to your specified length
MIS-300B	Aircraft Cable, 1/16" Galvanized steel cable cut to your specified length
MIS-300C	Aircraft Cable, 1/16" Steel, 3/32" O.D. PVC
MIS-300D	Aircraft Cable, 3/64" Galvanized, 7 x 7 Stranding



MIS-300

Spirators

Spirators & Spacers

S.E.E.S. #	Description
MIS-124	Spirator, 5" O.D., reel closer with combo hub
MIS-124-20PAC	Spirator, 5" O.D., economic pack of 20
MIS-124A	Mounting stud, 1-3/4" with threaded shaft for spirator
MIS-124B	Cable stud, 1-1/4" for spirator cable hitch
MIS-124C	Cable stud, 1-3/8" for spirator cable hitch
MIS-124E	Spirator, 5" O.D., Heavy Duty reel closer with combo hub
MIS-124E-KIT	Spirator Kit, 5" OD Heavy Duty Combo Hub with Spacers
MIS-124E-20PAC	Spirator, 5" O.D., Heavy Duty, economic pack of 20
MIS-124F	Spirator, Spirator, 4.125 D, 1.063 W
MIS-124G	Spirator, 5" O.D., with combo hub
MIS-124K USP22297	Closer, Reel Heavy Duty with Bracket
MIS-124S	Spirator Spacer Kit
MIS-124-KIT	Spirator Kit, Spirator, 5" O.D. with spacer kit
MIS-124-ST	Reel Closer, 6" SmarTork door closer up to 20% more tension
MIS-124-ST-BK	Bracket, for SmarTork door closer
MIS-124-ABK	Spirator Bracket with spacer for square shank
MIS-160	Bracket with square shank for MIS-124 Spirator
GDO-7	Bracket, 3-1/2" x 2-1/2", for MIS-124
WDO-34	Spirator, closing reel with cable, 6" diameter, Heavy Duty



MIS-124



MIS-124A



MIS-124B



MIS-124C



MIS-124E



MIS-124G



MIS-124-ST



MIS-124S



MIS-124-ST-BK



MIS-124-ABK



WDO-34



MIS-160

Door Keys

Manufactured to strict quality standards to meet or exceed OEM specifications. Highest quality materials are machined and plated to resist corrosion to ensure long lasting performance. *Ask about our quantity discounts.*

S.E.E.S. #	O.E.M. #	Description
MIS-119	INT1-0034N	Flapper Key with collar, for Montgomery, Dover, Haughton, Otis and GAL
MIS-119-P		Door Key , Flapper w/ Plastic Handle and flexible safety shaft
MIS-119T		Door Key , Emergency Door Key, 8" L with Flapper, universal
MIS-120		Access Key , 5/8" diameter x 3-1/4" L, 1/2" I.D.
MIS-121		Car Panel Key , 7/16" diameter x 4" L, 21/64" I.D.
MIS-121A	INT5-0030N	G.A.L. Key , door key Type M for swing doors
MIS-122		Door Key , 3-in-1 Type M GAL, Flapper
MIS-123		Door Key , 5-in-1 Type M GAL, Flapper, and Jumpers
MIS-KEYPAK		Keypack , value door key pack of 11 keys ODO-45, ODO-46, ODO-46A, ODO-46B, WDO-57, WDO-58, MIS-119, MIS-120, MIS-121, MIS-121A, HDO-1
SEES-KCDK-001		SEES Keychain Door Key , "GAL" Flapper Flexible Shaft with Key Ring
SEES-MULTI-KEY-001-SPS		Multi Key Tool , Side Plate Special Engrave
SEES-MULTI-KEY-001B		Multi Key Tool , T-Key, Single Drop & Lunar Blue Handle
SEES-MULTI-KEY-001B-SP		Multi Key Tool , T-Key, Single Drop & Lunar, Blue Handle, Special Engraving
SEES-MULTI-KEY-001BLK		Multi Key Tool , T-Key, Single Drop & Lunar Black Handle
SEES-MULTI-KEY-001BLK-SP		Multi Key Tool , T-Key, Single Drop & Lunar, Black Handle, Special Engraving
SEES-MULTI-KEY-001R		Multi Key Tool , T-Key, Single Drop & Lunar Red Handle
SEES-MULTI-KEY-002B-FZ1		Multi Key Tool , FEO, FL Zone 1 Key, Single Drop & Lunar, Blue Handle
SEES-MULTI-KEY-002B-FZ2		Multi Key Tool , FEO, FL Zone 2 Key, Single Drop & Lunar, Blue Handle
SEES-MULTI-KEY-002B-FZ3		Multi Key Tool , FEO, FL Zone 3 Key, Single Drop & Lunar, Blue Handle
SEES-MULTI-KEY-002B-FZ4		Multi Key Tool , FEO, FL Zone 4 Key, Single Drop & Lunar, Blue Handle
SEES-MULTI-KEY-002B-FZ5		Multi Key Tool , FEO, FL Zone 5 Key, Single Drop & Lunar, Blue Handle
SEES-MULTI-KEY-002B-FZ6		Multi Key Tool , FEO, FL Zone 6 Key, Single Drop & Lunar, Blue Handle
SEES-MULTI-KEY-002B-FZ7		Multi Key Tool , FEO, FL Zone 7 Key, Single Drop & Lunar, Blue Handle
SEES-MULTI-KEY-002R-FZ-SP		Multi Key Tool , FEO, FL Zone Key (Specify), Single Drop & Lunar, Red Handle, Special Markings
SEES-MULTI-KEY-003B		Multi Key Tool , T-Key, Single Drop & Lunar, Blue Handle, Door Lock Pick
SEES-MULTI-KEY-004B		Multi Key Tool , Single Drop & Lunar, Blue Handle, Allen Key Set
SEES-MULTI-KEY-005B		Multi Key Tool , Double Drop & Lunar, Blue Handle, T-Key Set
WDO-58E	W-824T-E	T-Key , Extended 15" OAL



MIS-119



MIS-119-P



MIS-120



MIS-121



MIS-121A



MIS-122



SEES-MULTI-KEY-001B



SEES-MULTI-KEY-001BLK



SEES-MULTI-KEY-002B-FZ7

Otis Keys

S.E.E.S. #	O.E.M. #	Description
ODO-45	194AD2	Lunar Key , 10-1/2" Emergency Hoistway
ODO-46	194AD7	Door Key , Double Drop
ODO-46A	194AD3	Door Key , Single drop
ODO-46-P	AAA194AZ1	Door Key , Double Drop, with Plastic Handle and flexible safety shaft
ODO-46A-P	AAA194AZ6	Door Key , Triple Drop, with Plastic Handle and flexible safety shaft
ODO-46B	194AD6	Close Couple Key
ODO-46C		Door Key , For GEN II Key Plastic Safety Handle
ODO-46D		Door Access Device for Gen II , Stainless Steel Escutcheon Tube and Hardware

Westinghouse Keys

S.E.E.S. #	O.E.M. #	Description
WDO-57	569A884H01	Lunar key , 6" L
WDO-58	W-824T	T-Key , 9" L
WDO-58E	W-824T-E	T-Key , Extended 15" OAL



ODO-45



ODO-46A

ODO-46

ODO-46B



ODO-46-P



ODO-46A-P



WDO-57



WDO-58



CUSTOMIZABLE MULTI-KEY!

PART#: SEES-MULTI-KEY-001B



OTHER KEYS AVAILABLE FOR CUSTOMIZATION:

MIS-121

MIS-121A

MIS-122

ODO-46



Always Smooth Sailing

2781 West McNab Rd, Pompano Beach, FL 33069 • (800) 526-0026 • www.SEESinc.com

Escutcheons

Hole plugs

S.E.E.S. #	O.E.M. #	Description
MIS-144C	7603	Plug, 1/2" Escutcheon chrome hole
MIS-144D	7604	Plug, 5/8" Escutcheon chrome hole
MIS-144E		Hole Plug, 3/4" Chrome Plated for Escutcheon
MIS-144F		Hole Plug, 1" Chrome Plated for Escutcheon
MIS-144G		Hole Plug, 1-1/4" Chrome Plated for Escutcheon
MIS-144H		Hole Plug, 1-3/8" Chrome Plated for Escutcheon
MIS-144M		Hole Plug, SS #4 Brush, Fits 1/4" hole up to 1-1/2" O.D.
MIS-144N		Hole Plug, Brass for 1/2" I.D. 1-3/4" L
MIS-144P		Hole Plug, Aluminum for 1/2" I.D. x 2" L
MIS-144R		Hole Plug, for 1/2" I.D. Hole x 1-3/4" L, 304SS #4 Brush
MIS-144Q		Hole Plug, for 5/8" I.D. Hole x 1.815" L, 304SS #4 Brush
MIS-210		Collar, Rubber Protective Key Collar, 2" diameter x 1/2" x 3/8" I.D.



MIS-144C



MIS-144E



MIS-144F



MIS-144G



MIS-144P



MIS-144Q

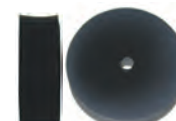

MIS-210

Escutcheons

S.E.E.S. #	O.E.M. #	Description
MIS-144		Escutcheon, Hall door key hole, 1-3/4" L for 3/8" diameter keys, 27/64" I.D., 15/16" O.D., 1-1/4" length threaded
MIS-144B		Escutcheon, Hall door key hole, 1-3/8" L, 7/16" I.D., 3/4" O.D.
MIS-144I		Escutcheon, door sleeve, brass, 1.5" L x .625" O.D. x .875" lip
MIS-144J		Escutcheon, Door Key Hole, Threaded, 1.5" L x .0625" dia., Lip=0.875", Aluminum
MIS-144K		Escutcheon, Door Key Hole, Threaded, 2.0" L x .0625" dia., Lip=0.875", Brass
MIS-144L		Escutcheon, Door Key Hole, Threaded, 2.0" L x .0625" dia., Lip=0.875", Aluminum
MIS-189V		Plug Lock, door Escutcheon with SEES #5 Key



MIS-144



MIS-144B



WDO-57A



WDO-57B

Westinghouse Escutcheons

S.E.E.S. #	O.E.M. #	Description
WDO-57A		Escutcheon, for lunar key, self-adhesive
WDO-57B		Escutcheon plate, for "T" key, 7/8" face, stainless steel finish



ODO-73



ODO-73A



ODO-73B

Otis Escutcheons

S.E.E.S. #	O.E.M. #	Description
ODO-73	321CVI	Escutcheon, Door Key Hole, 2.75" L x 0.5" dia., Lip=0.625" dia, Stainless Steel
ODO-73A	321CV5	Escutcheon, Door Key Hole, 2.75" L x 0.5" diameter, Lip=0.625" diameter, Brass
ODO-73B	386TZI-3	Escutcheon, for lunar key
ODO-73D		Escutcheon, Door Key Hole, 2.75" L x 0.5" diameter, Lip=0.625" dia, Aluminum
ODO-73E		Escutcheon, Door Key Hole, 2.0" L x 0.5" dia, Lip=0.625" dia, Stainless Steel
ODO-73F		Escutcheon, Door Key Hole, 2.0" L x 0.5" diameter, Lip=0.625" dia, Brass
ODO-73G		Escutcheon, Door Key Hole, 2.0" L x 0.5" diameter, Lip=0.625" dia, Aluminum
ODO-73H		Escutcheon, Door Key Hole, 1.5" L x 0.5" dia., Lip=0.625" dia, Stainless Steel
ODO-73I		Escutcheon, Door Key Hole, 1.5" L x 0.5" diameter, Lip=0.625" dia, Brass
ODO-73J		Escutcheon, Door Key Hole, 1.5" L x 0.5" diameter, Lip=0.625" dia, Aluminum
ODO-73K		Escutcheon, Door Sleeve, SS 1.75" L x .50" diameter x .625" Lip
ODO-73L		Escutcheon, Door Sleeve, Brass 1.75" L x .50" diameter x .625" Lip
ODO-73M		Escutcheon, Door Sleeve, Alum 1.75" L x .50" diameter x .625" Lip
ODO-73R		Escutcheon, Door Sleeve, Brass 3.25" L x .50" diameter x .625" Lip
ODO-73-SP-NUT		Escutcheon Speed Nut, 1/2" for ODO-73 series
ODO-73U		Escutcheon, Door Sleeve, Alum 4.0" L x .50" diameter x .625" Lip

Belts

Hi-Power® V-Belts

Offering excellent performance and superior strength. Patented construction features Flex Weave Cover and flex bonded tension cords. Belts are oil and heat resistant for reliability.

S.E.E.S. #	O.E.M. #	Outer Circumf.
MIS-BLT1	3VX250	25.0"
MIS-BLT2	3VX265	26.5"
MIS-BLT3	3VX280	28.0"
MIS-BLT4	3VX300	30.0"
MIS-BLT5	3VX315	31.5"
MIS-BLT6	3VX335	33.5"
MIS-BLT7	3VX355	35.5"
MIS-BLT8	3VX375	37.5"
MIS-BLT9	3VX400	40.0"
MIS-BLT10	3VX425	42.5"
MIS-BLT11	3VX450	45.0"
MIS-BLT12	3VX475	47.5"
MIS-BLT13	3VX500	50.0"
MIS-BLT14	3VX530	53.0"



MIS-BLT1 thru MIS-BLT22



MIS-BLT25

S.E.E.S. #	O.E.M. #	Outer Circumf.
MIS-BLT15	3VX560	56.0"
MIS-BLT16	3VX600	60.0"
MIS-BLT17	3VX630	63.0"
MIS-BLT17A	3V630	63.0"
MIS-BLT18	3VX670	67.0"
MIS-BLT19	3VX710	71.0"
MIS-BLT20	3VX750	75.0"
MIS-BLT21	3V800	80.0"
MIS-BLT22	3V950	95.0"
MIS-BLT25	B51	54.0"
MIS-BLT26	B53	56.0"
MIS-BLT23	B58	61.0"
MIS-BLT24	B71	73.0"
MIS-BLT24A	B70 5L730	73.0"
MIS-BLT27	5VX600	60"
MIS-BLT28	5V710	71"
MIS-BLT29	3VX560	56"
MIS-BLT32	AX31	33"
MIS-BLT33	5V750	75"

S.E.E.S. #	Description
MIS-BLT-PFT-001	Belt, Timing P5M-10 Sold Per Foot
MIS-BLT-PFT-002	Belt, Timing 8M-10 Sold Per Foot
MIS-BLT-PFT-003	Belt, Timing HTD5M-10 Sold Per Foot
MIS-BLT-PFT-004	Belt, Timing 8M-8 Sold Per Foot
MIS-BLT-PFT-005	Belt Neoprene, Drive, ESA (L8M12) Sold Per Foot
MIS-BLT-REEL-001	Belt, Timing P5M-10 200 Meter Reel (656 Feet)
MIS-BLT-REEL-002	Belt, Timing 8M-10 150 Meter Reel (492 Feet)
MIS-BLT-REEL-003	Belt, Timing HTD5M-10 150 Meter (492 Feet)
MIS-BLT-REEL-005	Belt Neoprene, Drive ESA (L8M12) 150 M = 492 FT.

■ For additional belts see pgs 560, 615, 650, 679, 790, 803, 891



Safety Edge

SEES Light Curtain

S.E.E.S. #	Description
SEES-SCREEN-001B	SEES Screen II, Light Curtain, blue/red combo, 120 VAC
SEES-SCREEN-001G	SEES Screen II, Light Curtain, green/red combo, 120 VAC
SEES-SCREEN-001N	SEES Screen II, Light Curtain, Door Edge with Nudging
SEES-SCREEN-001NC	SEES Screen II, Nudging, Power Supply Only
SEES-SCREEN-001C	SEES Screen II, 120 VAC Controller Only
SEES-SCREEN-001R	SEES Screen II, Receiver Only
SEES-SCREEN-001T	SEES Screen II, Transmitter Only
SEES-SCREEN-002N	SEES Screen II, Light Curtain Waterproof, with Nudging
SEES-SCREEN-HL-001A	SEES Screen II, 2 FT Light Curtain with 110 VAC
SEES-SCREEN-HL-002A	SEES Screen II, 5 FT Light Curtain with 110 VAC
SEES-SCREEN-HL-003A	SEES Screen II, 4 FT Light Curtain with 110 VAC
SEES-SCREEN-004	SEES Screen II, Light Curtain Standard, 24 VDC
SEES-SCREEN-004C	SEES Screen II, 24 VDC Controller only
SEES-SCREEN-005	SEES Screen II, Cable set Replacement cables
SEES-SCREEN-006	SEES Screen II, Light Curtain Standard, 220 VAC
SEES-SCREEN-006C	SEES Screen II, 220 VAC Controller Only
SEES-SCREEN-007	Replacement Connectors, 300V 10A
SEES-SCREEN-008	SEES Screen II, Light Curtain Slimline with 24 VDC Controller
SEES-SCREEN-009	SEES Screen II, Light Curtain MOVFR Direct Connect No Power Supply required for GAL MOVFR
SEES-SCREEN-HL-001	SEES Screen II, 2 FT Light Curtain Assembly with 24 VDC PS
SEES-SCREEN-HL-002	SEES Screen II, 5 FT Light Curtain Assembly with 24 VDC PS
SEES-SCREEN-HL-003	SEES Screen II, 4 FT Light Curtain Assembly with 24 VDC PS



CSA Approved

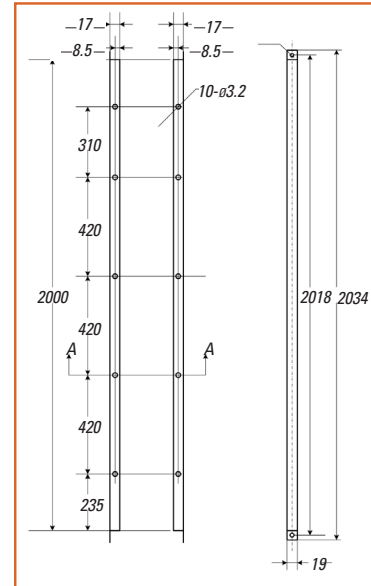

Plug Close Up

SEES-SCREEN-001N



Power Supply



Hardware

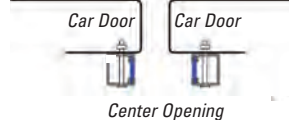
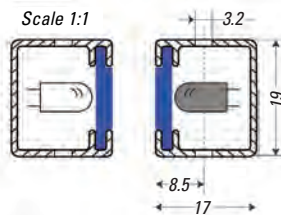

Center Opening

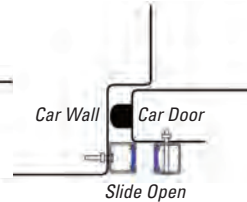

Slide Open



SEES-SCREEN-001C



SEES-SCREEN-005

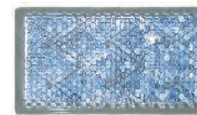

MIS-176

Electric Eye Assemblies

S.E.E.S. #	O.E.M. #	Description
MIS-176	0000182000	Reflector, electric eye, 2.75" x 1.25" with self adhesive
MIS-176A		Reflective tape, 2" W, specify length
MIS-176B		Reflective tape, 3" W, specify length
MIS-180	1004-H Duo-Path	Electric Eye, Dual Beam Photo eye assembly, includes power cable and adjustable mounting brackets



MIS-180

Safety Edge



MIS-SE-2

MIS-SE-2

- 64 Redundant IR LED's
- Dual voltage power supply 120/240 VAC
- Nudge/buzzer "ON" delay timer is adjustable from 5 to 45 sec. Buzzer can be easily disabled with selector switch.
- Totally immune to ANY ambient light, including strobes and fluorescent.
- Optional "Waterproof" models are available. Fully functional from -25° to $+158^{\circ}$ F (-4° C to 70° C).
- All models can be installed in either Center or Side parting doors.
- Automatic Dynamic Sensitivity Adjustment (DSA) compensates for severe misalignment, condensation & damaged or dirty lens; also provides on-the-fly dynamic adjustments of sensitivity as doors open or close.
- Energy management system improves reliability by automatically reducing power to LED's by 75% and to the power supply by 50% when elevator doors are closed.

Universal Safety Edge Replacement

S.E.E.S. #	O.E.M. #	Description
MIS-SE-1A		Safety Door Edge, E40/32 with Model 280 Power Supply
MIS-SE-2		Universal Safety Edge
MIS-SE-2A		Power Supply Board
MIS-SE-2B		P.C. Board, with nudging
MIS-SE-2C		Power Supply, in non-metallic housing
MIS-SE-2D		Cable, replacement for Light Beam
MIS-SE-2E		Cable, replacement for Receiver Beam
MIS-SE-2N		Universal Safety Edge, with nudging
MIS-SE-2-INT1	ECI-1	Interface Cable, ECI-1 for Magic Edge Power Supply
MIS-SE-2-INT3	ECI-3	Interface Cable, ECI-3 for GAL MOVFR Operator
MIS-SE-2-INT4	ECI-4	Interface Cable, ECI-4 for N.C.
MIS-SE-2-INT5	ECI-5	Interface Cable, ECI-5 for N.O.
MIS-SE-3		Universal Safety Edge, waterproof
MIS-SE-3N		Universal Safety Edge, waterproof with nudging
MIS-SE-4		Remote Control, door screen edge system
MIS-SE-4R		Remote Control, for MIS-SE-4 system



MIS-SE-2A



MIS-SE-2C



MIS-SE-2N



MIS-SE-2-INT1



MIS-SE-2-INT3



MIS-SE-3



MIS-SE-4



MIS-SE-4R

Safety Edge

S.E.E.S. #	Description
MIS-SE-5L	SEEScreen left hand combo standard Tx with slim-line Rx
MIS-SE-5L-GAL	SEEScreen LH combo for GAL MOVFR, standard Tx with slim-line Rx
MIS-SE-5M	SEEScreen mounting kit for R.H. & L.H. combo
MIS-SE-5R	SEEScreen right hand combo standard Rx with slim-line Tx
MIS-SE-5R-GAL	SEEScreen RH combo for GAL MOVFR standard Rx with slim-line Tx

S.E.E.S. #	O.E.M. #	Description
MIS-SE-6	A850G7	Gate Keeper, 7' unit with hardware
MIS-SE-6A	A850G10	Gate Keeper, 10' unit with hardware
MIS-SE-6B	GLS526D	3 Lane Sensor

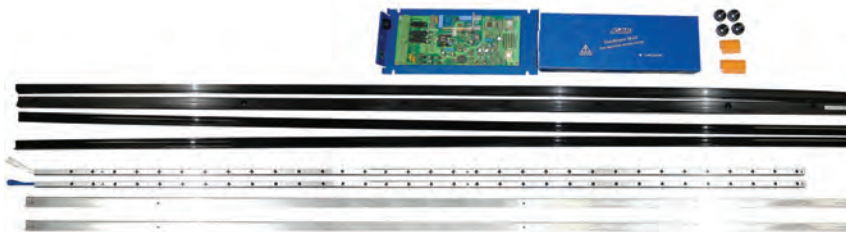

MIS-SE-6



MIS-SE-13



MIS-SE-9



MIS-SE-9E

S.E.E.S. #	Description
MIS-SE-7	SEEScreen, nudging Safety Edge set with Power Supply and hardware
MIS-SE-7N	SEEScreen, nudging Controller 115 VAC
MIS-SE-8	SEEScreen, water-proof Safety Edge set with Power Supply and hardware, IP67
MIS-SE-8A	SEEScreen, water-proof Receiver, IP67
MIS-SE-8B	SEEScreen, water-proof Transmitter, IP67
MIS-SE-9	Janus Door Edge, Pana-40
MIS-SE-9A	Janus Receiver, Pana-40
MIS-SE-9B	Janus Transmitter, Pana-40
MIS-SE-9C	Janus Power Supply, Pana-40
MIS-SE-9E	Janus Extension Cable, Pana-40 12.5' EA
MIS-SE-9F	Janus UPVC Lens cover, Pana-40
MIS-SE-9G	Janus Extension Kits, Pana-40
MIS-SE-10	Optiguard Kit
MIS-SE-11	Panachrome 3D, Complete Kit
MIS-SE-11V	Panachrome Voice Unit
MIS-SE-12	Edge Kit, Formula Systems MOVFR w/ Fully Integrate Power Supply
MIS-SE-12A	Edge Kit, Formula Systems FCU 47 MOD MOH Includes Universal Power Supply
MIS-SE-12B	Power Supply, Universal for Light Curtain 220/120 AC/DC, 24 VDC
MIS-SE-13	Panachrome Smart 3D, Complete
MIS-SE-14	Door Edge, InvisiGuard Razor, Includes Power Supply



MIS-SE-14

LOSING MONEY ON CALL BACKS?

Introducing...

SMARTORK

Elevator Hoistway
Door Closer



What does it do?

As the door closes, the innovative SMARTORK overcomes wind resistance by design. The SMARTORK, with its helical groove design, actually regains tension as it closes the door. SMARTORK provides more tension in the "door-close" cycle than it does in the "door-open" cycle. It's easy to install; just remove the "Old Style" unit and install the SMARTORK as a replacement. Call today and ask for SEES part number:

MIS-124-ST

Don't forget your brackets:

MIS-124-ST-BK

Contact Us!

800.526.0026

SMARTORK™



- 800.526.0026
- info@seesinc.com
- www.facebook.com/SEESinc

Visit Our Website:
www.seesinc.com

- ▶ The "Uni-hub" allows for easy installation
- ▶ SMARTORK saves money on non-chargeable and non-billable hours for elevator companies dealing with "Wind Resistance Issues"
- ▶ Reliable solution to nuisance call-backs
- ▶ Maintenance calls to add or remove "wraps" will virtually be a thing of the past once the SMARTORK is installed
- ▶ Rated "Green" under Energy Efficiency guidelines
- ▶ 3rd party tests over one-million cycles with virtually constant torque verify extended service-life tests
- ▶ 2 year warranty
- ▶ Made in the USA
- ▶ Acts as a safety device by securing door lock mechanisms

SMARTORK Meets or Exceeds ASME A17.1 and Related Codes

MIS-124-ST



A GREEN ENERGY PRODUCT

SMARTORK™

- ▶ SMARTORK replaces existing elevator hoistway door reel closers. SMARTORK solves many door-related problems and eliminates future maintenance.
- ▶ SMARTORK not only overcomes wind resistance but actually reduces spring force and energy required to open hoistway doors while increasing tension during close-cycle.
- ▶ SMARTORK is able to accomplish these actions by its revolutionary Patent Pending design. It's conical helix break-over design increases tension force in the last few inches of closing by an average of twenty percent more than when the door is opening. SMARTORK actually crosses the spring force ("Torque") and cable force ("Tension") ratios.

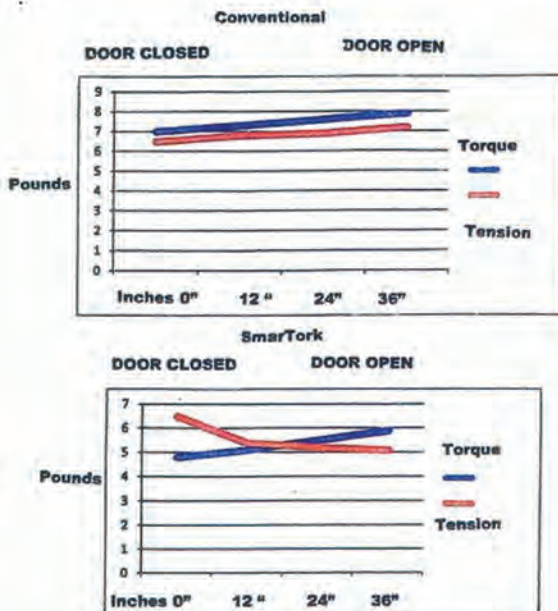

- ▶ Test have shown a reduction in Peak Amp loads by an average of .33 amps on every operation. This is a 9.2% power savings per cycle of the Elevator Door Operations. A "GREEN" energy saving product, SMARTORK, falls within ASHRAE 90.1 Guide Lines. As such, potential Tax breaks, Power rate adjustments, and Insurance Discounts may apply to building owners. SMARTORK Meets or exceeds ASME A17.1 and related Codes.
- ▶ SMARTORK reel-closer is molded from ABS Plastic to increase service life.
- ▶ The "Uni-hub" allows for easy installation or replacement to systems having a square shaft or dual pin mounting bracket configuration.
- ▶ SMARTORK saves money on non-chargeable and non-billable hours for elevator companies dealing with "Wind Resistance Issues". SMARTORK reduces maintenance costs by eliminating cord stretch and providing extended service life.
- ▶ SMARTORK was designed to replace all existing closers with a more reliable, safety enhanced and "GREEN" energy saving product.



MIS-124-ST



MIS-197



MIS-197A



MIS-197B



MIS-914A



MIS-914L



MIS-914M



MIS-914B



MIS-914F

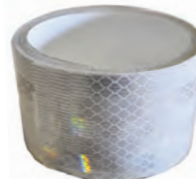

MIS-914-TAPE



MIS-914C



MIS-914H



MIS-915

Hatch Exit

S.E.E.S. #	O.E.M. #	Description
MIS-194-AB	A835BT	Battery , 12 V 2.9 AMP HR.
MIS-197		Ceiling Emergency Latch Switch . DPDT Switch allows for building security circuit to be notified, as well as separate circuit for car shut down or, as code requires. Requires manual latch reset from car top
MIS-197A	AAA6098NS1	Top of Car Exit , contact kit, plug type
MIS-197B	USP18576	Emergency Ceiling Exit , Switch Assembly, Car Top Escape
MIS-197D	6993C64G03	Emergency Ceiling Exit , Switch Assy, Westinghouse
MIS-197E	321C984G01	Emergency Ceiling Exit , Switch Kit, Westinghouse

Electric Door Latch Assembly

S.E.E.S. #	O.E.M. #	Description
MIS-914A	A835A3	Electric Door Restrictor Hatch Latch Assembly
MIS-914B	A835PL	Plunger , Replacement for MIS-914A
MIS-914C	A835PC4	PCB , Hatch Latch, replacement for MIS-914A
MIS-914F	A835PH	PhotoEye , with bracket and 9ft cable for Hatch Latch
MIS-914G	A835SYSBK	Solenoid , with 9ft cable and bracket for Hatch Latch
MIS-914H	A835S1	Solenoid , with 9ft cable and bracket for Hatch Latch
MIS-914I	A835SBA3	Solenoid Mounting Bracket , for Hatch Latch
MIS-914J	A835ZC	Solenoid Plunger Bracket , Z-bracket for Hatch Latch
MIS-914L	A835RA	Reflective Angle , for Hatch Latch
MIS-914M	A835BB	Bracket , stop 7GA 5" x 10" for Hatch Latch
MIS-914N	A835OPTO	Door Open Pilot , OPTO Module for Hatch Latch
MIS-914-T		Reflective Targets , Alum Plate with 4" x 18" Reflective Tape
MIS-914-TAPE		Reflective Tape , 2" wide roll of 10 ft
MIS-915	9894433	Tool , Taper pin extractor
MIS-916		Power Supply , Universal, #OTIS50E-EE
MIS-917		Power Supply , Bench, 3 Outputs
MIS-918		Power Supply , 220 VAC

THE SEES RESTRICTOR

S.E.E.S. #	Description
SEES-RESTRICTOR-001	SEES Door Restrictor, Cam 60" long, with hardware and shims
SEES-RESTRICTOR-001S	SEES Door Restrictor, Cam 60" long, Shallow Design with hardware and shims
SEES-RESTRICTOR-002	SEES Door Restrictor, Cam 50" long, with hardware & shims (GAL version)
SEES-RESTRICTOR-002S	SEES Door Restrictor, Cam 50" long, Shallow Design (low profile) with hardware and shims
SEES-RESTRICTOR-003	SEES Restrictor, Flag, Small Adjustable (1.25" to 1.875")
SEES-RESTRICTOR-004	SEES Restrictor, Flag, Large Adjustable (2" to 2.875")
SEES-RESTRICTOR-004A	SEES Restrictor, Flag, Large Adjustable (2" to 3.375")
SEES-RESTRICTOR-005	SEES Restrictor, Shim Kit with hardware
SEES-RESTRICTOR-006	SEES Restrictor, Flag, 1" Fixed length
SEES-RESTRICTOR-007	SEES Restrictor, Flag, 3" Fixed length
SEES-RESTRICTOR-008	SEES Restrictor, Hardware, bag of 50 M6 Hex Hd Tek
SEES-RESTRICTOR-009	SEES Restrictor, Cam 50" Long For Swing Door Application
SEES-RESTRICTOR-010	SEES Restrictor, Cam 84" Long for Tall Doors, with hardware and shims

* see pg 568 for more information on the SEES Door Restrictor.



Single Slide Top Retainers

S.E.E.S. #	Description
DW-200	Door Retainer, for Door Track, Right Hand
DW-201	Door Retainer, for Door Track, Left Hand
SEES-TDSR-001	Top Retainer, Otis door with integral hanger
SEES-TDSR-002	Top Retainer, Otis door with type 7060 or type B hanger
SEES-TDSR-003	Top Retainer, 1" Dahlstrom or Dillon door with Horn or GAL hangers
SEES-TDSR-004	Top Retainer, 1" Dahlstrom or Dillon with MAC hangers
SEES-TDSR-005	Top Retainer, 1-1/4" Tyler, Dahlstrom Cor-o-foam door with Horn or GAL hanger
SEES-TDSR-006	Top Retainer, 1-1/4" Tyler, Dahlstrom Cor-o-foam door with MAC hanger
SEES-TDSR-007	Top Retainer, 1-1/4" Tyler door with Westinghouse hanger and Tyler gib
SEES-TDSR-008	Top Retainer, 1-1/4" Armor 4C door with 4C hanger and aluminum sill
SEES-TDSR-009	Top Retainer, Dover or Turnbull Door with integral hangers
SEES-TDSR-009A	Top Retainer, SS Dover or Turnbull Door with integral hangers, 1-1/8" Door
SEES-TDSR-010	Top Retainer, Landing Door with Roelefson hangers
SEES-TDSR-011	Top Retainer, Landing Door equipped with Armor or GAL hangers and vandal-proof GAL lock
SEES-TDSR-012	Top Retainer, Dillon landing door with custom made hanger
SEES-TDSR-013	Top Retainer, Dillon landing door with custom made hanger, special
SEES-TDSR-030A	Top Retainer, CP Otis door with individual hangers, top retainers only
SEES-TDSR-044	Top Retainer, CP Otis door with individual hangers, top retainers only



DW-200



SEES-TDSR-001



SEES-TDSR-002



SEES-TDSR-004



SEES-TDSR-005



SEES-TDSR-030A



SEES-TDSR-044

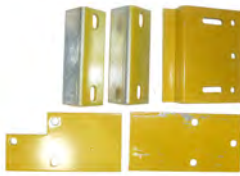

SEES-TDSR-016



SEES-TDSR-017

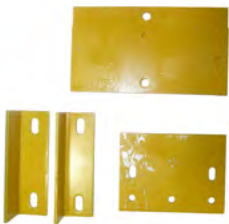

SEES-TDSR-019



SEES-TDSR-026



SEES-TDSR-037



SEES-TDSR-038

Single Slide Top Retainers

S.E.E.S. #	Description
SEES-TDSR-014	Top Retainer , Turnbull landing door with individual hangers
SEES-TDSR-015	Top Retainer , Dover landing door with individual hangers
SEES-TDSR-016	Top Retainer , Dahlstrom landing door with MAC integral hangers
SEES-TDSR-017	Top Retainer , Dahlstrom landing door with GAL integral hangers
SEES-TDSR-018	Top Retainer , Dahlstrom landing door with Otis integral hangers
SEES-TDSR-019	Top Retainer , Westinghouse landing door with integral hangers

Two Speed Top Retainers

S.E.E.S. #	Description
SEES-TDSR-020	Top Retainer , Two Speed GAL door with Gal Hangers (wide doors)
SEES-TDSR-021	Top Retainer , Two Speed Dahlstrom door with integral hangers
SEES-TDSR-022	Top Retainer , Two Speed Otis door with individual hangers
SEES-TDSR-023	Top Retainer , Two Speed Turnbull door with individual hangers
SEES-TDSR-024	Top Retainer , Two Speed MAC Door with individual hangers
SEES-TDSR-025	Top Retainer , Two Speed Dover Door with individual hangers
SEES-TDSR-026	Top Retainer , Two Speed GAL Door with GAL hangers (narrow door)
SEES-TDSR-027	Top Retainer , Two Speed Armor Door with individual hangers
SEES-TDSR-028	Top Retainer , Two Speed Otis Door with integral hangers
SEES-TDSR-029	Top Retainer , Two Speed Dover Door with integral hangers

Center Parting Top Retainers

S.E.E.S. #	Description
SEES-TDSR-030	Top Retainer , Center Parting Otis door with individual hangers
SEES-TDSR-031	Top Retainer , Center Parting Dahlstrom door with individual MAC hangers
SEES-TDSR-032	Top Retainer , Center Parting Dahlstrom door with integral hangers
SEES-TDSR-033	Top Retainer , Center Parting Armor Door with individual hangers on "J" track
SEES-TDSR-034	Top Retainer , Center Parting Turnbull door with individual hangers
SEES-TDSR-035	Top Retainer , Center Parting Dillon Door with Individual MAC hangers
SEES-TDSR-036	Top Retainer , Center Parting Otis Door with integral hangers
SEES-TDSR-037	Top Retainer , Center Parting door with Westinghouse individual hanger
SEES-TDSR-038	Top Retainer , Center Parting door with Dover integral hangers
SEES-TDSR-039	Top Retainer , Center Parting door with Westinghouse integral hangers
SEES-TDSR-040	Top Retainer , Center Parting door 1-1/4" thick with GAL individual hangers
SEES-TDSR-042	Top Retainer , Center Parting Otis door with individual hangers
SEES-TDSR-043	Top Retainer , Center Parting Dillon door with custom made hangers

Center Parting Two Speed Top Retainers

S.E.E.S. #	Description
SEES-TDSR-041	Top Retainer , Center Parting Two Speed Dover door with individual hangers